



RF TEST REPORT

Certificate No. : TBC-C-202601-0040-3
Report No. : TBR-C-202601-0040-5
Applicant : Heltec Automation Technology Co., Ltd
Equipment Under Test (EUT)
EUT Name : WiFi LoRa 32
Model No. : HTIT-WBR2H
HTIT-WB32LAF, HTIT-WBR2N, HTIT-WBR8H, HTIT-WBR8N,
HTIT-WBR8G, HTIT-WBN8G, HTIT-WBR2G, HTIT-WB32A,
Series Model No. : HTIT-WB32B, HTIT-WB32C, HTIT-WB32S, HTIT-WB32E1,
HTIT-WB32E2, HTIT-WB32E3, HTIT-WB32E4,
HTIT-WBNRT1, HTIT-WBNRT2
Brand Name : Heltec Automation
Receipt Date : 2026-04-09
Test Date : 2026-04-09 to 2026-05-19
Issue Date : 2026-05-20
Standards : ETSI EN 300 328 V2.2.2:2019
Conclusions : **PASS**

In the configuration tested, the EUT complied with the standards specified above. The EUT technically complies with the Council Directive 2014/53/EU relating to radio equipment.

Tested By : Lily Zhang

Reviewed By : Wade W

Approved By : Ivan Su



This report details the results of the testing carried out on one sample. The results contained in this test report do not relate to other samples of the same product. The manufacturer should ensure that all products in series production are in conformity with the product sample detailed in the report.

TB-RF-073-3.1

TABLE OF CONTENTS

1 GENERAL INFORMATION.....5

1.1 Client Information.....5

1.2 General Description of EUT (Equipment Under Test)5

1.3 Block Diagram Showing the Configuration of System Tested.....9

1.4 Description of Support Units9

1.5 Description of Operating Mode.....10

1.6 Measurement Uncertainty11

1.7 Test Facility.....11

2 TEST RESULTS SUMMARY12

3 TEST SOFTWARE.....13

4 TEST EQUIPMENT AND TEST SITE.....14

5 RF OUTPUT POWER.....16

5.1 Test Standard and Limit.....16

5.2 Test Setup.....16

5.3 Test Procedure.....16

5.4 Deviation From Test Standard.....17

5.5 EUT Operating Mode17

5.6 Test Data.....17

6 POWER SPECTRAL DENSITY.....18

6.1 Test Standard and Limit.....18

6.2 Test Setup.....18

6.3 Test Procedure.....18

6.4 Deviation From Test Standard.....20

6.5 EUT Operating Mode20

6.6 Test Data.....20

7 DUTY CYCLE, TX-SEQUENCE, TX-GAP.....21

7.1 Test Standard and Limit.....21

7.2 Test Setup.....21

7.3 Test Procedure.....21

7.4 Deviation From Test Standard.....22

7.5 EUT Operating Mode22

7.6 Test Data.....22

8 MEDIUM UTILIZATION.....23

8.1 Test Standard and Limit.....23

8.2 Test Setup.....23

8.3 Test Procedure.....23

8.4 Deviation From Test Standard.....23

8.5 EUT Operating Mode23

8.6 Test Data.....23

9 ADAPTIVITY24

9.1 Test Standard and Limit.....24

9.2 Test Setup.....24

9.3 Test Procedure.....24

9.4 Deviation From Test Standard.....25

9.5 EUT Operating Mode25

9.6 Test Data.....25



10	OCCUPIED CHANNEL BANDWIDTH	26
	10.1 Test Standard and Limit	26
	10.2 Test Setup.....	26
	10.3 Test Procedure.....	26
	10.4 Deviation From Test Standard.....	26
	10.5 EUT Operating Mode	26
	10.6 Test Data.....	26
11	TRANSMITTER UNWANTED EMISSIONS IN THE OUT-OF-BAND DOMAIN	27
	11.1 Test Standard and Limit	27
	11.2 Test Setup.....	27
	11.3 Test Procedure.....	27
	11.4 Deviation From Test Standard.....	29
	11.5 EUT Operating Mode	29
	11.6 Test Data.....	29
12	RECEIVER BLOCKING	30
	12.1 Test Standard and Limit	30
	12.2 Test Setup.....	32
	12.3 Test Procedure.....	32
	12.4 Deviation From Test Standard.....	34
	12.5 EUT Operating Mode	34
	12.6 Test Data.....	34
13	GEO-LOCATION CAPABILITY.....	35
	13.1 Test Standard and Limit	35
	13.2 Deviation From Test Standard.....	35
	13.3 Test Data.....	35
14	TRANSMITTER UNWANTED EMISSIONS IN THE SPURIOUS DOMAIN.....	36
	14.1 Test Standard and Limit	36
	14.2 Test Setup.....	36
	14.3 Test Procedure.....	37
	14.4 Deviation From Test Standard.....	39
	14.5 EUT Operating Mode	39
	14.6 Test Data.....	39
15	RECEIVER SPURIOUS EMISSIONS	46
	15.1 Test Standard and Limit	46
	15.2 Test Setup.....	46
	15.3 Test Procedure.....	47
	15.4 Deviation From Test Standard.....	48
	15.5 EUT Operating Mode	48
	15.6 Test Data.....	48
16	PHOTOGRAPHS--TEST SETUP	55



1 General Information

1.1 Client Information

Applicant	:	Heltec Automation Technology Co., Ltd
Address	:	1f, No. 54, 56, 58, Zirui North Street, Gaoxin District, Chengdu, China
Manufacturer	:	Heltec Automation Technology Co., Ltd
Address	:	1f, No. 54, 56, 58, Zirui North Street, Gaoxin District, Chengdu, China

1.2 General Description of EUT (Equipment Under Test)

EUT Name	:	WiFi LoRa 32	
Model No.	:	HTIT-WBR2H, HTIT-WB32LAF, HTIT-WBR2N, HTIT-WBR8H, HTIT-WBR8N, HTIT-WBR8G, HTIT-WBN8G, HTIT-WBR2G, HTIT-WB32A, HTIT-WB32B, HTIT-WB32C, HTIT-WB32S, HTIT-WB32E1, HTIT-WB32E2, HTIT-WB32E3, HTIT-WB32E4, HTIT-WBNRT1, HTIT-WBNRT2	
Model Difference	:	All these models are identical in the same PCB layout and electrical circuit, only difference is model name.	
Product Description	:	Operation Frequency:	Bluetooth LE: 2402MHz~2480MHz
		Modulation Type:	GFSK
		Bit Rate of Transmitter:	1Mbps&2Mbps
		Channel Separation:	2MHz
		Number of Channel:	Please see Note(4)
		Antenna Gain:	0.93dBi FPC Antenna
Power Rating	:	INPUT: DC 5.0V	
Software Version	:	N/A	
Hardware Version	:	N/A	
<p>Remark: The antenna gain provided by the applicant, the verified for the RF conduction test provided by TOBY test lab. The above antenna information is declared by manufacturer and for more detailed features description, please refer to the manufacturer's specifications, the laboratory shall not be held responsible.</p>			

Note:

- (1) For a more detailed features description, please refer to the manufacturer's specifications or the User's Manual.
- (2) This Test Report is ETSI EN 300 328 for Bluetooth function, under RED Article 3.2.



(3) The Product Information**a) The type of modulation used by the equipment:**

- FHSS
- other forms of modulation

b) In case of FHSS modulation:

- In case of non-Adaptive Frequency Hopping equipment:
 - The number of Hopping Frequencies:
- In case of Adaptive Frequency Hopping Equipment:
 - The maximum number of Hopping Frequencies:
 - The minimum number of Hopping Frequencies:
 - The Dwell Time:

c) Adaptive / non-adaptive equipment:

- non-adaptive Equipment
- adaptive Equipment without the possibility to switch to a non-adaptive mode
- adaptive Equipment which can also operate in a non-adaptive mode

d) In case of adaptive equipment:

The Channel Occupancy Time implemented by the equipment:

- The equipment has implemented an LBT based DAA mechanism
 - In case of equipment using modulation different from FHSS:
 - The equipment is Frame Based equipment
 - The equipment is Load Based equipment
- The equipment can switch dynamically between Frame Based and Load Based equipment
 - The CCA time implemented by the equipment: μ s
 - The equipment has implemented an non-LBT based DAA mechanism
 - The equipment can operate in more than one adaptive mode

e) In case of non-adaptive Equipment:

The maximum RF Output Power (e.i.r.p.): dBm

The maximum (corresponding) Duty Cycle:

Equipment with dynamic behaviour, that behaviour is described here. (e.g. the different combinations of duty cycle and corresponding power levels to be declared):

f) The worst case operational mode for each of the following tests:

- RF Output Power
 - GFSK
- Power Spectral Density
 - GFSK
- Duty cycle, Tx-Sequence, Tx-gap
- Dwell time, Minimum Frequency Occupation & Hopping Sequence (only for FHSS equipment)
- Accumulated Transmit time, Frequency Occupation & Hopping Sequence (only for FHSS equipment)
- Hopping Frequency Separation (only for FHSS equipment)
- Medium Utilisation
-
- Adaptivity & Receiver Blocking
 - GFSK
- Nominal Channel Bandwidth
 - GFSK
- Transmitter unwanted emissions in the OOB domain
 - GFSK



- Transmitter unwanted emissions in the spurious domain
GFSK
- Receiver spurious emissions
GFSK

g) The different transmit operating modes (tick all that apply):

- Operating mode 1: Single Antenna Equipment
 - Equipment with only 1 antenna
 - Equipment with 2 diversity antennas but only 1 antenna active at any moment in time
 - Smart Antenna Systems with 2 or more antennas, but operating in a (legacy) mode where only 1 antenna is used. (e.g. IEEE 802.11™ [i.3] legacy mode in smart antenna systems)
 - Operating mode 2: Smart Antenna Systems - Multiple Antennas without beam forming
 - Single spatial stream / Standard throughput / (e.g. IEEE 802.11™ [i.3] legacy mode)
 - High Throughput (> 1 spatial stream) using Occupied Channel Bandwidth 1
 - High Throughput (> 1 spatial stream) using Occupied Channel Bandwidth 2
- NOTE: Add more lines if more channel bandwidths are supported.
- Operating mode 3: Smart Antenna Systems - Multiple Antennas with beam forming
 - Single spatial stream / Standard throughput (e.g. IEEE 802.11™ [i.3] legacy mode)
 - High Throughput (> 1 spatial stream) using Occupied Channel Bandwidth 1
 - High Throughput (> 1 spatial stream) using Occupied Channel Bandwidth 2
- NOTE: Add more lines if more channel bandwidths are supported.

h) In case of Smart Antenna Systems:

- The number of Receive chains:
- The number of Transmit chains:
 - symmetrical power distribution
 - asymmetrical power distribution

In case of beam forming, the maximum beam forming gain:

NOTE: Beam forming gain does not include the basic gain of a single antenna.

i) Operating Frequency Range(s) of the equipment:

- Operating Frequency Range 1: **2402 MHz to 2480 MHz**
- Operating Frequency Range 2:
- Operating Frequency Range 3:

NOTE: Add more lines if more Frequency Ranges are supported.

j) Nominal Channel Bandwidth(s):

- Occupied Channel Bandwidth 1: **1.022MHz**
- Occupied Channel Bandwidth 2: **2.034MHz**
- Occupied Channel Bandwidth 3:
- Occupied Channel Bandwidth 4:
- Occupied Channel Bandwidth 5:

NOTE: Add more lines if more channel bandwidths are supported.

k) Type of Equipment (stand-alone, combined, plug-in radio device, etc.):

- Stand-alone
- Combined Equipment (Equipment where the radio part is fully integrated within another type of equipment)
 - Plug-in radio device (Equipment intended for a variety of host systems)
 - Other

l) The extreme operating conditions that apply to the equipment:

Operating temperature range: **-20° C to 70° C**

Operating voltage range: **3.0 to 5.5V** □AC ■DC

- Details provided are for the: ■stand-alone equipment
 □combined (or host) equipment



test jig

m) The intended combination(s) of the radio equipment power settings and one or more antenna assemblies and their corresponding e.i.r.p levels:

- Antenna Type
 - FPC Antenna
 - Antenna Gain: ***0.93dBi***
 - If applicable, additional beamforming gain (excluding basic antenna gain): dB
 - Temporary RF connector provided
 - No temporary RF connector provided
 - Dedicated Antennas (equipment with antenna connector)
 - Single power level with corresponding antenna(s)
 - Multiple power settings and corresponding antenna(s)
 - Number of different Power Levels:
 - Power Level 1: dBm
 - Power Level 2: dBm
 - Power Level 3: dBm

NOTE 1: Add more lines in case the equipment has more power levels.
NOTE 2: These power levels are conducted power levels (at antenna connector).

n) The nominal voltages of the stand-alone radio equipment or the nominal voltages of the combined (host) equipment or test jig in case of plug-in devices:

Details provided are for the: ■ stand-alone equipment
 combined (or host) equipment
 test jig

Supply Voltage AC mains State
 ■ DC State DC voltage: DC 5V

In case of DC, indicate the type of power source
 Internal Power Supply
 ■ External Power Supply or AC/DC adapter
 Battery
 Other:

o) Describe the test modes available which can facilitate testing:
The EUT can transmit with test software: **EspRFTestTool_v3.6_Manual**

p) The equipment type (e.g. Bluetooth®, IEEE 802.11™ [i.3], proprietary, etc.):
Bluetooth LE

q) If applicable, the statistical analysis referred to in clause 5.3.1q:

r) If applicable, the statistical analysis referred to in clause 5.3.1r:

- s) Geo-location capability, supported by the equipment:**
- Yes
 - The geographical location determined by the equipment as defined in clause 4.3.1.13.2 or clause 4.3.2.12.2 is not accessible to the user.
 - No

t) Describe the minimum performance criteria that apply to the equipment (see clause 4.3.1.12.3 or clause 4.3.2.11.3):

The minimum performance criterion shall be a PER less than or equal to 10%.
.....
The intended use of the equipment should be in the normal operation without lost the communication link or no unintentionally operation occurs.
.....



(4) Channel List:

Bluetooth LE Channel List					
Channel	Frequency (MHz)	Channel	Frequency (MHz)	Channel	Frequency (MHz)
00	2402	14	2430	28	2458
01	2404	15	2432	29	2460
02	2406	16	2434	30	2462
03	2408	17	2436	31	2464
04	2410	18	2438	32	2466
05	2412	19	2440	33	2468
06	2414	20	2442	34	2470
07	2416	21	2444	35	2472
08	2418	22	2446	36	2474
09	2420	23	2448	37	2476
10	2422	24	2450	38	2478
11	2424	25	2452	39	2480
12	2426	26	2454		
13	2428	27	2456		

1.3 Block Diagram Showing the Configuration of System Tested

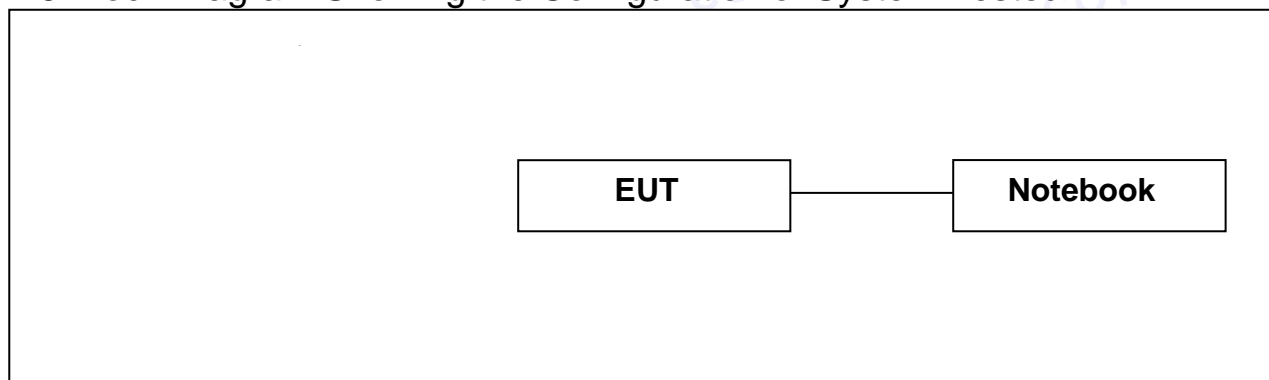

1.4 Description of Support Units

Equipment Information				
Name	Model	S/N	Manufacturer	Used “√”
Notebook	inspiron 5509	----	DELL	√



1.5 Description of Operating Mode

To investigate the maximum EMI emission characteristics generated from EUT, the test system was pre-scanning tested based on the consideration of following EUT operation mode or test configuration mode which possible have effect on EMI emission level. Each of these EUT operation mode(s) or test configuration mode(s) mentioned above was evaluated respectively.

Test Mode	Mode	Data Rate	Channel
Continuously Transmitting/Receiving	BLE/GFSK	1&2Mbps	00/19/39

The EUT system operated these modes were found to be the worst case during the pre-scanning test as Following:

For Radiated Test(Below 1GHz)	
Transmit mode(BLE1Mbps 2402MHz)	
Receive mode(2402MHz)	
For Radiated Test(Above 1GHz)	
Transmit mode(BLE1Mbps 2402/2480MHz)	
Receive mode(2402/2480MHz)	
Note: the report only show the worst case data.	
Parameters	10

Normal Temperature(NT):	22°C~26°C
Relative Humidity:	25% to 65%
Air Pressure:	980-1020hPa
Extreme Temperature:	Low Temperature (LT)=-20°C High Temperature (HT)= +70°C
Normal Voltage of EUT (NV):	DC 5.0V
Extreme Voltage of the EUT:	Low Voltage(LV)= 3.0V High Voltage(HV)= 5.5V
Remark: The extreme temperature and extreme voltage of the EUT is declared by the manufacturer.	



1.6 Measurement Uncertainty

The reported uncertainty of measurement $y \pm U$, where expanded uncertainty U is based on a standard uncertainty multiplied by a coverage factor of $k=2$, providing a level of confidence of approximately 95 %.

Test Item	Expanded Uncertainty (U_{Lab})
Radiated Emission (30MHz to 1000 MHz)	± 4.50 dB
Radiated Emission (Above 1000MHz)	± 4.20 dB
RF Power-Conducted	± 0.95 dB
Power Spectral Density-Conducted	± 3 dB
Occupied Bandwidth	$\pm 3.8\%$
Unwanted Emission-Conducted	± 2.72 dB
Temperature	$\pm 0.6^{\circ}\text{C}$
Humidity	$\pm 4\%$
Supply voltages	$\pm 2\%$
Time	$\pm 4\%$

1.7 Test Facility

The testing report were performed by the Shenzhen Toby Technology Co., Ltd., in their facilities located at 1/F., Building 6, Rundongsheng Industrial Zone, Longzhu, Xixiang, Bao'an District, Shenzhen, Guangdong, China. At the time of testing, the following bodies accredited the Laboratory:

CNAS (L5813)

The Laboratory has been accredited by CNAS to ISO/IEC 17025: 2017 General Requirements for the Competence of Testing and Calibration Laboratories for the competence in the field of testing. And the Registration No.: CNAS L5813.

A2LA Certificate No.: 4750.01

The laboratory has been accredited by American Association for Laboratory Accreditation(A2LA) to ISO/IEC 17025: 2017 General Requirements for the Competence of Testing and Calibration Laboratories for the technical competence in the field of Electrical Testing. And the A2LA Certificate No.: 4750.01.FCC Accredited Test Site Number: 854351. Designation Number: CN1223.

IC Registration No.: (11950A)

The Laboratory has been registered by Certification and Engineering Bureau of Industry Canada for radio equipment testing. The site registration: Site# 11950A. CAB identifier: CN0056.



2 Test Results Summary

Harmonized Standard ETSI EN 300 328 Relationship between the present document and the essential requirements of Directive 2014/53/EU							
Essential Requirement			Requirement Conditionality		Test Specification		
No	Description	Reference: Clause No	U/C	Condition	E/O	Reference: Clause No	Observations
1	RF Output Power	4.3.1.2 or 4.3.2.2	U		E	5.4.2	PASS
2	Power Spectral Density	4.3.2.3	C	Only for non-FHSS equipment	E	5.4.3	PASS
3	Duty Cycle, Tx-Sequence, TX-gap	4.3.1.3 or 4.3.2.4	C	Only for non-adaptive equipment	E	5.4.2	N/A Note(3)
4	Accumulated Transmit time, Frequency Occupation & Hopping Sequence	4.3.1.4	C	Only for FHSS equipment	E	5.4.4	N/A
5	Hopping Frequency Separation	4.3.1.5	C	Only for FHSS equipment	E	5.4.5	N/A
6	Medium Utilization	4.3.1.6 or 4.3.2.5	C	Only for non-adaptive equipment	E	5.4.2	N/A Note(3)
7	Adaptivity	4.3.1.7 or 4.3.2.6	C	Only for adaptive equipment		5.4.6	N/A Note(3)
8	Occupied Channel Bandwidth	4.3.1.8 or 4.3.2.7	U		E	5.4.7	PASS
9	Transmitter unwanted emission in the OOB domain	4.3.1.9 or 4.3.2.8	U		E	5.4.8	PASS
10	Transmitter unwanted emissions in the spurious domain	4.3.1.10 or 4.3.2.9	U		E	5.4.9	PASS
11	Receiver spurious emissions	4.3.1.11 or 4.3.2.10	U		E	5.4.10	PASS
12	Receiver Blocking	4.3.1.12 or 4.3.2.11	U		E	5.4.11	PASS
13	Geo-location Capability	4.3.1.13 or 4.3.2.12	C	Only for equipment with geo-location capability	X		N/A

Note:
 (1) "U/C": indicates whether the requirement is to be unconditionally applicable (U) or is conditional upon the manufacturers claimed functionality of the equipment (C).
 "Condition": Explains the conditions when the requirement shall or shall not be applicable for a technical requirement which is classified "conditional"
 "E/O": indicates whether the test specification forms part of the Essential Radio Test Suite (E) or whether it is one of the Other Test Suite (O).
 "X": indicates there is no test specified corresponding to the requirement.



"N/A": indicates test is not applicable in this Test Report.

- (2) The equipment must be complied with as a necessary condition for presumption of conformity, although conformance with the requirement may be claimed by an equivalent test or by manufacturer's assertion supported by appropriate entries in the technical construction file.
- (3) This requirement does not apply for equipment with a maximum declared RF Output power level of less than 10 dBm e.i.r.p. for equipment when operating in a mode where the RF Output power is less than 10 dBm e.i.r.p.
- (4) The equipment was supplied by Host system, so the upper extreme test voltage shall be 1.1 times the nominal voltage of the battery, and the lower extreme test voltage shall be 0.9 times the nominal voltage of the Host system.

3 Test Software

Test Item	Test Software	Manufacturer	Version No.
Radiation Emission	EZ-EMC	EZ	Ver.GARAD-3A1.1+
Radiation Emission	EZ-EMC	EZ	Ver.GARAD-3A1.1+
RF Conducted Measurement	MTS-8310	MWRFtest	V2.0.0.0
RF Test System	JS1120	Tonscend	V3.6.21



4 Test Equipment and Test Site

Test Site					
No.	Test Site	Manufacturer	Specification	Used	
TB-EMCSR001	Shielding Chamber #1	YIHENG	7.5*4.0*3.0 (m)	X	
TB-EMCSR002	Shielding Chamber #2	YIHENG	8.0*4.0*3.0 (m)	√	
TB-EMCCA001	3m Anechoic Chamber #A	ETS	9.0*6.0*6.0 (m)	X	
TB-EMCCB002	3m Anechoic Chamber #B	YIHENG	9.0*6.0*6.0 (m)	√	

Radiation Emission Test (B Site)					
Equipment	Manufacturer	Model No.	Serial No.	Last Cal.	Cal. Due Date
Spectrum Analyzer	Agilent	N9020A	MY49100060	Aug. 27, 2025	Aug. 26, 2026
Spectrum Analyzer	Rohde & Schwarz	FSV40-N	102197	Jun. 16, 2025	Jun. 15, 2026
EMI Test Receiver	Rohde & Schwarz	ESU-8	100472/008	Jan. 30, 2026	Jan. 29, 2027
Bilog Antenna	SCHWARZBECK	VULB 9168	1225	Oct. 18, 2025	Oct. 17, 2027
Horn Antenna	SCHWARZBECK	BBHA 9120 D	2463	Jun. 14, 2024	Jun. 13, 2026
Horn Antenna	SCHWARZBECK	BBHA 9170	1118	Jan. 31, 2026	Jan. 30, 2028
Loop Antenna	SCHWARZBECK	FMZB 1519 B	1519B-059	Jun. 14, 2024	Jun. 13, 2026
HF Amplifier	Tonscend	TAP9E6343	AP21C806117	Aug. 27, 2025	Aug. 26, 2026
HF Amplifier	Tonscend	TAP051845	AP21C806141	Aug. 27, 2025	Aug. 26, 2026
HF Amplifier	Tonscend	TAP0184050	AP21C806129	Feb. 02, 2026	Feb. 01, 2027
Highpass Filter	CD	HPM-6.4/18G	---	N/A	N/A
Highpass Filter	CD	HPM-2.8/18G	---	N/A	N/A
Highpass Filter	XINBO	XBLBQ-HTA67(8-25G)	22052702-1	N/A	N/A
Antenna Conducted Emission					
Equipment	Manufacturer	Model No.	Serial No.	Last Cal.	Cal. Due Date
Spectrum Analyzer	Agilent	E4407B	MY45106456	Jun. 16, 2025	Jun. 15, 2026
Spectrum Analyzer	Rohde & Schwarz	FSV40-N	102197	Jun. 16, 2025	Jun. 15, 2026
MXA Signal Analyzer	KEYSIGHT	N9020B	MY60110172	Aug. 27, 2025	Aug. 26, 2026
MXA Signal Analyzer	Agilent	N9020A	MY47380425	Aug. 27, 2025	Aug. 26, 2026
Vector Signal Generator	Agilent	N5182A	MY50141294	Aug. 27, 2025	Aug. 26, 2026
Analog Signal Generator	Agilent	N5181A	MY48180463	Aug. 27, 2025	Aug. 26, 2026
Vector Signal Generator	KEYSIGHT	N5182B	MY59101429	Aug. 27, 2025	Aug. 26, 2026
Analog Signal Generator	KEYSIGHT	N5173B	MY61252685	Aug. 27, 2025	Aug. 26, 2026
RF Power Sensor	DARE!! Instruments	RadiPowerRPR3006W	17100015SNO26	Aug. 27, 2025	Aug. 26, 2026
	DARE!! Instruments	RadiPowerRPR3006W	17100015SNO29	Aug. 27, 2025	Aug. 26, 2026
	DARE!! Instruments	RadiPowerRPR3006W	17100015SNO31	Aug. 27, 2025	Aug. 26, 2026
	DARE!! Instruments	RadiPowerRPR3006W	17100015SNO33	N/A	N/A
RF Control Unit	Tonsced	JS0806-1	21C8060380	Aug. 27, 2025	Aug. 26, 2026
RF Control Unit	Tonsced	JS0806-2	21F8060439	N/A	N/A
Power Control Box	Tonsced	JS0806-4ADC	21C8060387	Aug. 27, 2025	Aug. 26, 2026



Wideband Radio Communication Tester	Rohde & Schwarz	CMW500	144382	Aug. 27, 2025	Aug. 26, 2026
Universal Radio Communication Tester	Rohde & Schwarz	CMW500	168796	Jan. 30, 2026	Jan. 29, 2027
Temperature and Humidity Chamber	ZhengHang	ZH-QTH-225D	ZH2107290	Jun. 16, 2025	Jun. 15, 2026



5 RF Output Power

5.1 Test Standard and Limit

5.1.1 Test Standard

ETSI EN 300 328 V2.2.2:2019 clause 4.3.2.2

5.1.2 Test Limit

The RF output power for non-FHSS equipment shall be equal to or less than 20 dBm.

NOTE: For Non-adaptive FHSS equipment, the manufacturer may have declared a reduced RF Output Power (see clause 5.4.1 m)) and associated Duty Cycle (see clause 5.4.1 e)) that will ensure that the equipment meets the requirement for the Medium Utilization (MU) factor further described in clause 4.3.2.5. This is verified by the conformance test referred to in clause 4.3.2.5.4.

For non-adaptive non-FHSS equipment, where the manufacturer has declared an RF output power of less than 20 dBm e.i.r.p., the RF output power shall be equal to or less than that declared value.

This limit shall apply for any combination of power level and intended antenna assembly.

5.2 Test Setup

Normal Condition

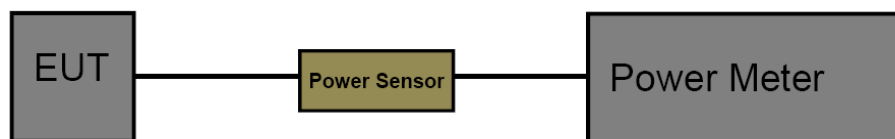

Extreme Condition

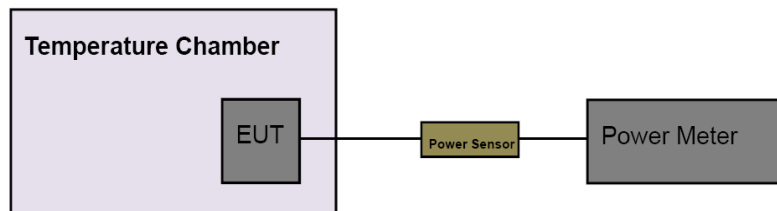

5.3 Test Procedure

The test procedure shall be as follows:

Step 1:

- Use a fast power sensor with a minimum sensitivity of -40 dBm and capable of minimum 1 MS/s.
- Use the following settings:
 - Sample speed 1 MS/s or faster.
 - The samples shall represent the RMS power of the signal.
 - Measurement duration: For non-adaptive equipment: equal to the observation period defined in clause 4.3.1.3.2 or clause 4.3.2.4.2. For adaptive equipment, the measurement duration shall be long enough to ensure a minimum number of bursts (at least 10) is captured.

For adaptive equipment, to increase the measurement accuracy, a higher number of bursts may be used.

Step 2:

- For conducted measurements on devices with one transmit chain:



- Connect the power sensor to the transmit port, sample the transmit signal and store the raw data. Use these stored samples in all following steps.
- For conducted measurements on devices with multiple transmit chains:
 - Connect one power sensor to each transmit port for a synchronous measurement on all transmit ports.
 - Trigger the power sensors so that they start sampling at the same time. Make sure the time difference between the samples of all sensors is less than 500 ns.
 - For each individual sampling point (time domain), sum the coincident power samples of all ports and store them. Use these summed samples as the new stored data set.

Step 3:

- Find the start and stop times of each burst in the stored measurement samples. The start and stop times are defined as the points where the power is at least 30 dB below the highest value of the stored samples in step 2. In case of insufficient sensitivity of the power sensor (e.g. in case of radiated measurements), the value of 30 dB may need to be reduced appropriately.

Step 4:

- Between the start and stop times of each individual burst calculate the RMS power over the burst using the formula below. The start and stop points shall be included. Save these Pburst values, as well as the start and stop times for each burst.

$$P_{burst} = \frac{1}{k} \sum_{n=1}^k P_{sample}(n)$$

with k being the total number of samples and n the actual sample number.

Step 5:

- The highest of all Pburst values (value A in dBm) will be used for maximum e.i.r.p. calculations.

Step 6:

- Add the (stated) antenna assembly gain G in dBi of the individual antenna.
- In case of smart antenna systems operating in mode with beamforming (see clause 5.3.2.2.4), add the additional beamforming gain Y in dB.
- If more than one antenna assembly is intended for this power setting, the maximum overall antenna gain (G or G + Y) shall be used.
- The RF Output Power (Pout) shall be calculated using the formula below:

$$P_{out} = A + G + Y$$

- This value, which shall comply with the limit given in clause 4.3.1.2.3 or clause 4.3.2.2.3, shall be recorded in the test report.

5.4 Deviation From Test Standard

No deviation

5.5 EUT Operating Mode

For non-FHSS equipment, the measurement shall be performed at the lowest, the middle, and the highest channel on which the equipment can operate. These frequencies shall be recorded.

The measurements for RF output power shall be performed at both normal environmental conditions and at the extremes of the operating temperature range.

5.6 Test Data

Please refer to the Appendix for BLE.



6 Power Spectral Density

6.1 Test Standard and Limit

6.1.1 Test Standard

ETSI EN 300 328 V2.2.2:2019 clause 4.3.2.3

6.1.2 Test Limit

The maximum Power Spectral Density for non-FHSS equipment is 10 dBm per MHz.

6.2 Test Setup

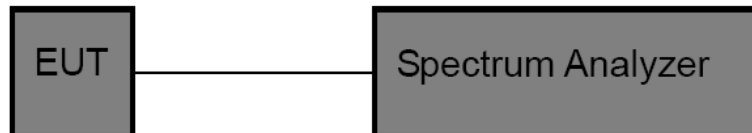

6.3 Test Procedure

Option 1: For equipment with continuous and non-continuous transmissions

The test procedure shall be as follows:

Step 1:

Connect the UUT to the spectrum analyser and use the following settings:

- Start Frequency: 2 400 MHz
- Stop Frequency: 2 483,5 MHz
- Resolution BW: 10 kHz
- Video BW: 30 kHz
- Sweep Points: > 8 350; for spectrum analysers not supporting this number of sweep points, the frequency band may be segmented
- Detector: RMS
- Trace Mode: Max Hold
- Sweep time:

For non-continuous transmissions: $2 \times \text{Channel Occupancy Time} \times \text{number of sweep points}$

For non-adaptive equipment use the maximum TX-sequence time in the formula above instead of the Channel Occupancy Time

For continuous transmissions: 10 s; the sweep time may be increased further until a value where the sweep time has no further impact anymore on the RMS value of the signal For non-continuous signals, wait for the trace to stabilize. Save the data (trace data) set to a file.

Step 2:

For conducted measurements on smart antenna systems using either operating mode 2 or operating mode 3 (see clause 5.3.2.2), repeat the measurement for each of the transmit ports. For each sampling point (frequency domain), add up the coincident power values (in mW) for the different transmit chains and use this as the new data set.

Step 3:

Add up the values for power for all the samples in the file using the formula below.



$$P_{Sum} = \sum_{n=1}^k P_{sample}(n)$$

with k being the total number of samples and n the actual sample number

Step 4:

Normalize the individual values for power (in dBm) so that the sum is equal to the RF Output Power (e.i.r.p.) measured in clause 5.4.2 and save the corrected data. The following formulas can be used:

$$C_{Corr} = P_{Sum} - P_{e.i.r.p.}$$

$$P_{Samplecorr}(n) = P_{Sample}(n) - C_{Corr}$$

with n being the actual sample number

Step 5:

Starting from the first sample $P_{Samplecorr}(n)$ (lowest frequency), add up the power (in mW) of the following samples representing a 1 MHz segment and record the results for power and position (i.e. sample #1 to sample #100). This is the Power Spectral Density (e.i.r.p.) for the first 1 MHz segment which shall be recorded.

Step 6:

Shift the start point of the samples added up in step 5 by one sample and repeat the procedure in step 5 (i.e. sample #2 to sample #101).

Step 7:

Repeat step 6 until the end of the data set and record the Power Spectral Density values for each of the 1 MHz segments.

From all the recorded results, the highest value is the maximum Power Spectral Density (PSD) for the UUT. This value, which shall comply with the limit given in clause 4.3.2.3.3, shall be recorded in the test report.

Option 2: For equipment with continuous transmission capability

This option is for equipment that can be configured to operate in a continuous transmit mode (100 % DC).

Step 1:

- Connect the UUT to the spectrum analyser and use the following settings:
 - Centre Frequency: The centre frequency of the channel under test
 - RBW: 1 MHz
 - VBW: 3 MHz
 - Frequency Span: At least 2 × Occupied Channel Bandwidth
 - Detector Mode: Peak
 - Trace Mode: Max Hold

Step 2:

- When the trace is complete, find the peak value of the power envelope and record the frequency.

Step 3:



- Make the following changes to the settings of the spectrum analyser:
 - Centre Frequency: Equal to the frequency recorded in step 2
 - Frequency Span: 3 MHz
 - RBW: 1 MHz
 - VBW: 3 MHz
 - Sweep Time: 1 minute
 - Detector Mode: RMS
 - Trace Mode: Max Hold

Step 4:

- Wait until the trace has stabilized, the trace shall be captured using the "Hold" or "View" option on the spectrum analyser.
- Find the peak value of the trace and place the analyser marker on this peak. This level is recorded as the highest mean power (power spectral density) D in a 1 MHz band.
- Alternatively, where a spectrum analyser is equipped with a function to measure power spectral density, this function may be used to display the power spectral density D in dBm / MHz.
- In case of conducted measurements on smart antenna systems operating in a mode with multiple transmit chains active simultaneously, the power spectral density of each transmit chain shall be measured separately to calculate the total power spectral density (value D in dBm / MHz) for the UUT.

Step 5:

- The maximum Power Spectral Density (PSD) e.i.r.p. is calculated from the above measured power spectral density D, the applicable antenna assembly gain G in dBi and if applicable the beamforming gain Y in dB, according to the formula below. This value shall be recorded in the test report. If more than one antenna assembly is intended for this power setting, the gain of the antenna assembly with the highest gain shall be used.

$$\text{PSD} = D + G + Y \text{ (dBm / MHz)}$$

6.4 Deviation From Test Standard

No deviation

6.5 EUT Operating Mode

The measurement shall be repeated for the equipment being configured to operate at the lowest, the middle, and the highest frequency of the stated frequency range. These frequencies shall be recorded.

These measurements shall only be performed at normal test conditions.

6.6 Test Data

Please refer to the Appendix for BLE.



7 Duty Cycle, Tx-Sequence, Tx-Gap

7.1 Test Standard and Limit

7.1.1 Test Standard

ETSI EN 300 328 V2.2.2:2019 clause 4.3.2.4

7.1.2 Test Limit

Non-FHSS equipment shall comply with the following:

- The Duty Cycle shall be equal to or less than the maximum value declared by the manufacturer.
- The Tx-sequence time shall be equal to or less than 10 ms.
- The minimum Tx-gap time following a Tx-sequence shall be equal to the duration of that proceeding Txsequence with a minimum of 3,5 ms.

NOTE: For Non-adaptive FHSS equipment, the manufacturer may have declared a reduced RF Output Power (see clause 5.4.1 m)) and associated Duty Cycle (see clause 5.4.1 e)) that will ensure that the equipment meets the requirement for the Medium Utilization (MU) factor further described in clause 4.3.2.5. This is verified by the conformance test referred to in clause 4.3.2.5.4.

7.2 Test Setup

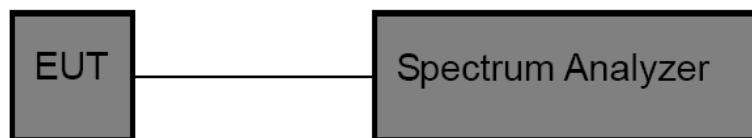

7.3 Test Procedure

The test procedure, which shall only be performed for non-adaptive equipment, shall be as follows:

Step 1:

- Use the same stored measurement samples from the procedure described in clause 5.4.2.2.1.2.
- The start and stop times are defined as the points where the power is at least 30 dB below the highest value of the stored samples. In case of insufficient sensitivity of the power sensor (e.g. in case of radiated measurements), the value of 30 dB may need to be reduced appropriately.

Step 2:

- Between the saved start and stop times of each individual burst, calculate the TxOn time. Save these TxOn values.

Step 3:

- Duty Cycle (DC) is the sum of all TxOn times between the end of the first gap (which is the start of the first burst within the observation period) and the start of the last burst (within this observation period) divided by the observation period. The observation period is defined in clause 4.3.1.3.2 or clause 4.3.2.4.2.

Step 4:

- For FHSS equipment using blacklisting, the TxOn time measured for a single (and active) hopping frequency shall be multiplied by the number of blacklisted frequencies. This value shall be added to the sum calculated in step 3 above. If the number of blacklisted frequencies cannot be determined, the minimum number of hopping frequencies (N) as



defined in clause 4.3.1.4.3 shall be assumed.

- The calculated value for Duty Cycle (DC) shall be recorded in the test report. This value shall be equal to or less than the maximum value declared by the manufacturer.

Step 5:

- Use the same stored measurement samples from the procedure described in clause 5.4.2.2.1.2.
- Identify any T_{xoff} time that is equal to or greater than the minimum Tx-gap time as defined in clause 4.3.1.3.3 or clause 4.3.2.4.3. These are the potential valid gap times to be further considered in this procedure.
- Starting from the second identified gap, calculate the time from the start of this gap to the end of the preceding gap. This time is the Tx-sequence time for this transmission. Repeat this procedure until the last identified gap within the observation period is reached.
- A combination of consecutive Tx-sequence times and Tx-gap times followed by a Tx-gap time, which is at least as long as the duration of this combination, may be considered as a single Tx-sequence time and in which case it shall comply with the limits defined in clause 4.3.1.3.3 or clause 4.3.2.4.3.
- It shall be noted in the test report whether the UUT complies with the limits for the maximum Tx-sequence time and minimum Tx-gap time as defined in clause 4.3.1.3.3 or clause 4.3.2.4.3.

7.4 Deviation From Test Standard

No deviation

7.5 EUT Operating Mode

For non-FHSS equipment, the measurement shall be performed at the lowest, the middle, and the highest channel on which the equipment can operate. These frequencies shall be recorded.

7.6 Test Data

- (1) The EUT is adaptive equipment and does not support non-adaptive mode, hence this requirement is not applicable. or
- (2) The EUT RF output power less than 10 dBm, hence this requirement is not applicable.



8 Medium Utilization

8.1 Test Standard and Limit

8.1.1 Test Standard

ETSI EN 300 328 V2.2.2:2019 clause 4.3.2.5

8.1.2 Test Limit

The maximum Medium Utilization factor for non-adaptive non-FHSS equipment shall be 10 %.

8.2 Test Setup

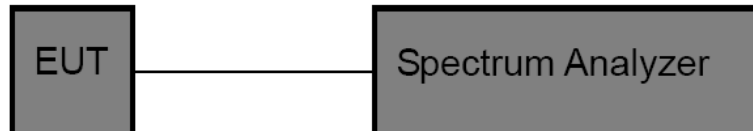

8.3 Test Procedure

The test procedure, which shall only be performed for non-adaptive equipment, shall be as follows:

Step 1:

- Use the same stored measurement samples from the procedure described in clause 5.4.2.2.1.2.

Step 2:

- For each burst calculate the product of $(P_{burst} / 100 \text{ mW})$ and the T_{xOn} time. P_{burst} is expressed in mW. T_{xOn} time is expressed in ms.

Step 3:

- Medium Utilization is the sum of all these products divided by the observation period (expressed in ms) which is defined in clause 4.3.1.3.2 or clause 4.3.2.4.2. This value, which shall comply with the limit given in clause 4.3.1.6.3 or clause 4.3.2.5.3, shall be recorded in the test report.

If, in case of FHSS equipment, operation without blacklisted frequencies is not possible, the power of the bursts on blacklisted hopping frequencies (for the calculation of the Medium Utilization) is assumed to be equal to the average value of the RMS power of the bursts on all active hopping frequencies.

8.4 Deviation From Test Standard

No deviation

8.5 EUT Operating Mode

For non-FHSS equipment, the measurement shall be performed at the lowest, the middle, and the highest channel on which the equipment can operate. These frequencies shall be recorded.

8.6 Test Data

- (1) The EUT is adaptive equipment and does not support non-adaptive mode, hence this requirement is not applicable. or
- (2) The EUT RF output power less than 10 dBm, hence this requirement is not applicable.



9 Adaptivity

9.1 Test Standard and Limit

9.1.1 Test Standard

ETSI EN 300 328 V2.2.2:2019 clause 4.3.2.6

9.1.2 Test Limit

<p>Non-LBT based Detect and Avoid:</p> <p>1 The frequency shall remain unavailable for a minimum time equal to 1second after which the channel maybe considered again as an „available“ channel;</p> <p>2 $COT \leq 40 \text{ ms}$;</p> <p>3 Idle Period = 5% of COT;</p> <p>4 Detection threshold level = $-70 \text{ dBm/MHz} + 10 \times \log_{10} (100\text{mW}/P_{\text{out}}) / (P_{\text{out}} \text{ in mW e.i.r.p.})$</p>
<p>LBT based Detect and Avoid (Frame Based Equipment):</p> <p>1 Minimum Clear Channel Assessment (CCA) time = 18 us;</p> <p>2 CCA observation time declared by the supplier;</p> <p>3 $COT = 1 \sim 10 \text{ ms}$;</p> <p>4 Idle Period = 5% of COT;</p> <p>5 Detection threshold level = $-70 \text{ dBm/MHz} + 10 \times \log_{10} (100\text{mW}/P_{\text{out}}) / (P_{\text{out}} \text{ in mW e.i.r.p.})$</p>
<p>LBT based Detect and Avoid (Load Based Equipment):</p> <p>1 Minimum Clear Channel Assessment (CCA) time = 18 us;</p> <p>2 CCA declared by the manufacturer;</p> <p>3 $COT \leq 13\text{ms}$;</p> <p>4 Detection threshold level = $-70 \text{ dBm/MHz} + 10 \times \log_{10} (100\text{mW}/P_{\text{out}}) / (P_{\text{out}} \text{ in mW e.i.r.p.})$</p>
<p>Short Control Signalling Transmissions: Short Control Signalling Transmissions shall have a maximum duty cycle $T_{X\text{On}} / (T_{X\text{On}} + T_{X\text{Off}})$ ratio of 10 % within any observation period of 50 ms.</p>

9.2 Test Setup

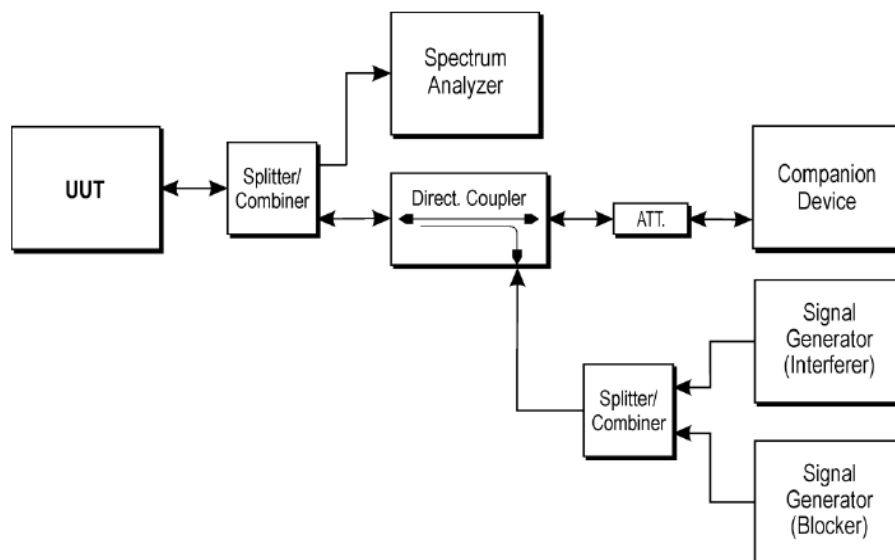

9.3 Test Procedure

Please refer to ETSI EN 300 328 (V2.2.2) clause 5.4.6.



9.4 Deviation From Test Standard

No deviation

9.5 EUT Operating Mode

When supported by the operating frequency range of the equipment, this test shall be performed on two operating (hopping) frequencies randomly selected from the operating frequencies used by the equipment. The first (lower) frequency shall be randomly selected within the range 2 400 MHz to 2 442 MHz while the second (higher) frequency shall be randomly selected within the range 2 442 MHz to 2 483,5 MHz. The equipment shall be in a normal operating (hopping) mode. In case of FHSS equipment, it shall be ensured that none of the test frequencies are blacklisted, otherwise another test frequency shall be selected.

These measurements shall only be performed at normal test conditions.

9.6 Test Data

The EUT RF output power less than 10 dBm, hence this requirement is not applicable.



10 Occupied Channel Bandwidth

10.1 Test Standard and Limit

10.1.1 Test Standard

ETSI EN 300 328 V2.2.2:2019 clause 4.3.2.7

10.1.2 Test Limit

The Occupied Channel Bandwidth shall be within the band given in table 1. In addition, for non-adaptive non-FHSS equipment with e.i.r.p. greater than 10 dBm, the Occupied Channel Bandwidth shall be equal to or less than 20 MHz.

Table 1: Service frequency bands

	Service frequency bands
Transmit	2 400 MHz to 2 483,5 MHz
Receive	2 400 MHz to 2 483,5 MHz

10.2 Test Setup

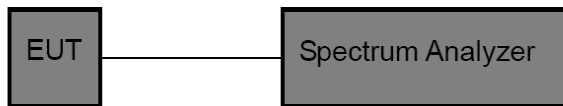

10.3 Test Procedure

The measurement procedure shall be as follows:

Step 1:

Connect the UUT to the spectrum analyser and use the following settings:

- Centre Frequency: The centre frequency of the channel under test
- Resolution BW: ~ 1 % of the span without going below 1 %
- Video BW: 3 × RBW
- Frequency Span: 2 × Nominal Channel Bandwidth
- Detector Mode: RMS
- Trace Mode: Max Hold
- Sweep time: 1 s

Step 2:

Wait for the trace to stabilize.

Find the peak value of the trace and place the analyser marker on this peak.

Step 3:

Use the 99 % bandwidth function of the spectrum analyser to measure the Occupied Channel Bandwidth of the UUT. This value shall be recorded.

Make sure that the power envelope is sufficiently above the noise floor of the analyser to avoid the noise signals left and right from the power envelope being taken into account by this measurement.

10.4 Deviation From Test Standard

No deviation

10.5 EUT Operating Mode

The measurement shall be performed only on the lowest and the highest frequency within the stated frequency range.

These measurements shall only be performed at normal test conditions.

In case of conducted measurements on smart antenna systems (equipment with multiple transmit chains) measurements need only to be performed on one of the active transmit chains (antenna outputs).

10.6 Test Data

Please refer to the Appendix for BLE.



11 Transmitter Unwanted Emissions in the out-of-band Domain

11.1 Test Standard and Limit

11.1.1 Test Standard

ETSI EN 300 328 V2.2.2:2019 clause 4.3.2.8

11.1.2 Test Limit

The transmitter unwanted emissions in the out-of-band domain shall not exceed the values provided by the mask in figure 3.

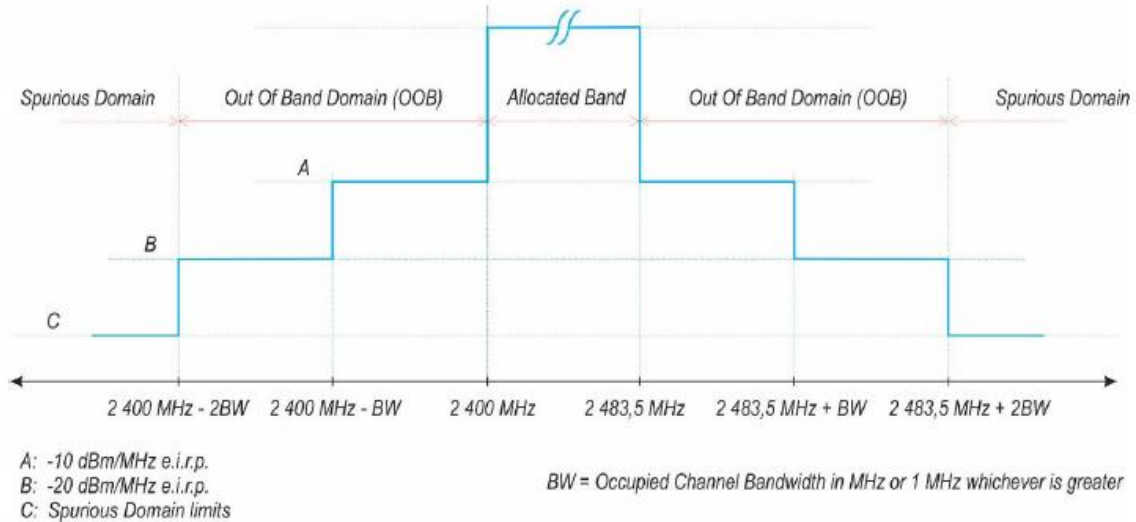
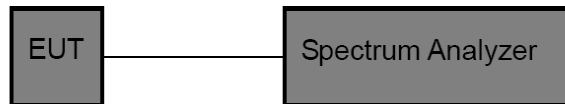

Figure 3: Transmit mask

11.2 Test Setup



11.3 Test Procedure

The applicable mask is defined by the measurement results from the tests performed under clause 5.4.7 (Occupied Channel Bandwidth).

The Out-of-band emissions within the different horizontal segments of the mask provided in figure 1 and figure 3 shall be measured using the procedure in step 1 to step 6 below. This method assumes the spectrum analyser is equipped with the Time Domain Power option.

Step 1:

- Connect the UUT to the spectrum analyser and use the following settings:
- Measurement Mode: Time Domain Power
- Centre Frequency: 2 484 MHz
- Span: Zero Span
- Resolution BW: 1 MHz
- Filter mode: Channel filter
- Video BW: 3 MHz
- Detector Mode: RMS
- Trace Mode: Max Hold
- Sweep Mode: Single Sweep



-
- | | |
|-----------------|---|
| - Sweep Points: | Sweep time [μ s] / (1 μ s) with a maximum of 30 000 |
| - Trigger Mode: | Video |
| - Sweep Time: | > 120 % of the duration of the longest burst detected during the measurement of the RF Output Power |

Step 2 (segment 2483,5 MHz to 2483,5 MHz + BW):

- The measurement shall be performed and repeated while the trigger level is increased until no triggering takes place.
- For FHSS equipment operating in a normal hopping mode, the different hops will result in signal bursts with different power levels. In this case the burst with the highest power level shall be selected.
- Set a window (start and stop lines) to match with the start and end of the burst and in which the RMS power shall be measured using the Time Domain Power function.
- Select RMS power to be measured within the selected window and note the result which is the RMS power within this 1 MHz segment (2483,5 MHz to 2484,5 MHz). Compare this value with the applicable limit provided by the mask.
- Increase the centre frequency in steps of 1 MHz and repeat this measurement for every 1 MHz segment within the range 2483,5 MHz to 2483,5 MHz + BW. The centre frequency of the last 1 MHz segment shall be set to 2483,5 MHz + BW - 0,5 MHz (which means this may partly overlap with the previous 1 MHz segment).

Step 3 (segment 2483,5 MHz + BW to 2483,5 MHz + 2 BW):

- Change the centre frequency of the analyser to 2 484 MHz + BW and perform the measurement for the first 1 MHz segment within range 2 483,5 MHz + BW to 2 483,5 MHz + 2 BW. Increase the centre frequency in 1 MHz steps and repeat the measurements to cover this whole range. The centre frequency of the last 1 MHz segment shall be set to 2483,5 MHz + 2 BW - 0,5 MHz (which means this may partly overlap with the previous 1 MHz segment).

Step 4 (segment 2400 MHz - BW to 2400 MHz):

- Change the centre frequency of the analyser to 2 399,5 MHz and perform the measurement for the first 1 MHz segment within range 2400 MHz - BW to 2400 MHz. Reduce the centre frequency in 1 MHz steps and repeat the measurements to cover this whole range. The centre frequency of the last 1 MHz segment shall be set to 2400 MHz - BW + 0,5 MHz (which means this may partly overlap with the previous 1 MHz segment).

Step 5 (segment 2400 MHz - 2 BW to 2400 MHz - BW):

- Change the centre frequency of the analyser to 2399,5 MHz - BW and perform the measurement for the first 1 MHz segment within range 2400 MHz - 2 BW to 2400 MHz - BW. Reduce the centre frequency in 1 MHz steps and repeat the measurements to cover this whole range. The centre frequency of the last 1 MHz segment shall be set to 2400 MHz - 2 BW + 0,5 MHz (which means this may partly overlap with the previous 1 MHz segment).

Step 6:

- In case of conducted measurements on equipment with a single transmit chain, the declared antenna assembly gain G in dBi shall be added to the results for each of the 1 MHz segments and compared with the limits provided by the mask given in figure 1 or figure 3. If more than one antenna assembly is intended for this power setting, the antenna with the highest gain shall be considered.
- In case of conducted measurements on smart antenna systems (equipment with multiple transmit chains), the measurements need to be repeated for each of the active transmit chains. The declared antenna assembly gain G in dBi for a single antenna shall be added to these results. If more than one antenna assembly is intended for this power setting, the



antenna with the highest gain shall be considered. Comparison with the applicable limits shall be done using any of the options given below:

- Option 1: the results for each of the transmit chains for the corresponding 1 MHz segments shall be added. The additional beamforming gain Y in dB shall be added as well and the resulting values compared with the limits provided by the mask given in figure 1 or figure 3.

- Option 2: the limits provided by the mask given in figure 1 or figure 3 shall be reduced by $10 \times \log_{10}(A_{ch})$ and the additional beamforming gain Y in dB. The results for each of the transmit chains shall be individually compared with these reduced limits.

NOTE: A_{ch} refers to the number of active transmit chains.

It shall be recorded whether the equipment complies with the mask provided in figure 1 or figure 3.

11.4 Deviation From Test Standard

No deviation

11.5 EUT Operating Mode

These measurements shall only be performed at normal test conditions.

For FHSS equipment, the measurements shall be performed during normal operation (hopping).

For non-FHSS equipment, the measurement shall be performed at the lowest and the highest channel on which the equipment can operate. These operating channels shall be recorded.

The equipment shall be configured to operate under its worst case situation with respect to output power.

If the equipment can operate with different Nominal Channel Bandwidths (e.g. 20 MHz and 40 MHz), then each channel bandwidth shall be tested separately.

11.6 Test Data

Please refer to the Appendix for BLE.



12 Receiver Blocking

12.1 Test Standard and Limit

12.1.1 Test Standard

ETSI EN 300 328 V2.2.2:2019 clause 4.3.2.11

12.1.2 Test Limit

For equipment that supports a PER or FER test to be performed, the minimum performance criterion shall be a PER or FER less than or equal to 10 %.

For equipment that does not support a PER or a FER test to be performed, the minimum performance criterion shall be no loss of the wireless transmission function needed for the intended use of the equipment.

While maintaining the minimum performance criteria as defined in clause 4.3.1.11.3, the blocking levels at specified frequency offsets shall be equal to or greater than the limits defined for the applicable receiver category provided in table 14, table 15 or table 16.

Table 14: Receiver Blocking parameters for Receiver Category 1 equipment

Wanted signal mean power from companion device (dBm) (see notes 1 and 4)	Blocking signal frequency (MHz)	Blocking signal power (dBm) (see note 4)	Type of blocking signal
(-133 dBm + 10 × log ₁₀ (OCBW)) or -68 dBm whichever is less (see note 2)	2 380 2 504	-34	CW
(-139 dBm + 10 × log ₁₀ (OCBW)) or -74 dBm whichever is less (see note 3)	2 300 2 330 2 360 2 524 2 584 2 674		
<p>NOTE 1: OCBW is in Hz.</p> <p>NOTE 2: In case of radiated measurements using a companion device and the level of the wanted signal from the companion device cannot be determined, a relative test may be performed using a wanted signal up to P_{min} + 26 dB where P_{min} is the minimum level of wanted signal required to meet the minimum performance criteria as defined in clause 4.3.1.12.3 in the absence of any blocking signal.</p> <p>NOTE 3: In case of radiated measurements using a companion device and the level of the wanted signal from the companion device cannot be determined, a relative test may be performed using a wanted signal up to P_{min} + 20 dB where P_{min} is the minimum level of wanted signal required to meet the minimum performance criteria as defined in clause 4.3.1.12.3 in the absence of any blocking signal.</p> <p>NOTE 4: The level specified is the level at the UUT receiver input assuming a 0 dBi antenna assembly gain. In case of conducted measurements, this level has to be corrected for the (in-band) antenna assembly gain (G). In case of radiated measurements, this level is equivalent to a power flux density (PFD) in front of the UUT antenna with the UUT being configured/positioned as recorded in clause 5.4.3.2.2.</p>			



Table 15: Receiver Blocking parameters receiver Category 2 equipment

Wanted signal mean power from companion device (dBm) (see notes 1 and 3)	Blocking signal frequency (MHz)	Blocking signal power (dBm) (see note 3)	Type of blocking signal
(-139 dBm + 10 × log ₁₀ (OCBW) + 10 dB) or (-74 dBm + 10 dB) whichever is less (see note 2)	2 380 2 504 2 300 2 584	-34	CW
<p>NOTE 1: OCBW is in Hz. NOTE 2: In case of radiated measurements using a companion device and the level of the wanted signal from the companion device cannot be determined, a relative test may be performed using a wanted signal up to P_{min} + 26 dB where P_{min} is the minimum level of wanted signal required to meet the minimum performance criteria as defined in clause 4.3.1.12.3 in the absence of any blocking signal. NOTE 3: The level specified is the level at the UUT receiver input assuming a 0 dBi antenna assembly gain. In case of conducted measurements, this level has to be corrected for the (in-band) antenna assembly gain (G). In case of radiated measurements, this level is equivalent to a power flux density (PFD) in front of the UUT antenna with the UUT being configured/positioned as recorded in clause 5.4.3.2.2.</p>			

Table 16: Receiver Blocking parameters receiver Category 3 equipment

Wanted signal mean power from companion device (dBm) (see notes 1 and 3)	Blocking signal frequency (MHz)	Blocking signal power (dBm) (see note 3)	Type of blocking signal
(-139 dBm + 10 × log ₁₀ (OCBW) + 20 dB) or (-74 dBm + 20 dB) whichever is less (see note 2)	2 380 2 504 2 300 2 584	-34	CW
<p>NOTE 1: OCBW is in Hz. NOTE 2: In case of radiated measurements using a companion device and the level of the wanted signal from the companion device cannot be determined, a relative test may be performed using a wanted signal up to P_{min} + 30 dB where P_{min} is the minimum level of wanted signal required to meet the minimum performance criteria as defined in clause 4.3.1.12.3 in the absence of any blocking signal. NOTE 3: The level specified is the level at the UUT receiver input assuming a 0 dBi antenna assembly gain. In case of conducted measurements, this level has to be corrected for the (in-band) antenna assembly gain (G). In case of radiated measurements, this level is equivalent to a power flux density (PFD) in front of the UUT antenna with the UUT being configured/positioned as recorded in clause 5.4.3.2.2.</p>			

Receiver category 1:

The following equipment shall be categorized as receiver category 1 equipment:

- Adaptive equipment with a maximum RF output power greater than 10 dBm e.i.r.p.

NOTE: Non-adaptive equipment is categorized as receiver category 2 or receiver category 3.

Receiver category 2:

The following equipment shall be categorized as receiver category 2 equipment:

- non-adaptive equipment with a Medium Utilization (MU) factor greater than 1 % and less than or equal to 10 % (irrespective of the maximum RF output power); or
- equipment (adaptive or non-adaptive) with a maximum RF output power greater than 0 dBm e.i.r.p. and less than or equal to 10 dBm e.i.r.p.

Receiver category 3:

The following equipment shall be categorized as receiver category 3 equipment:

- non-adaptive equipment with a maximum Medium Utilization (MU) factor of 1 % (irrespective of the maximum RF output power); or
- equipment (adaptive or non-adaptive) with a maximum RF output power of 0 dBm e.i.r.p.



12.2 Test Setup

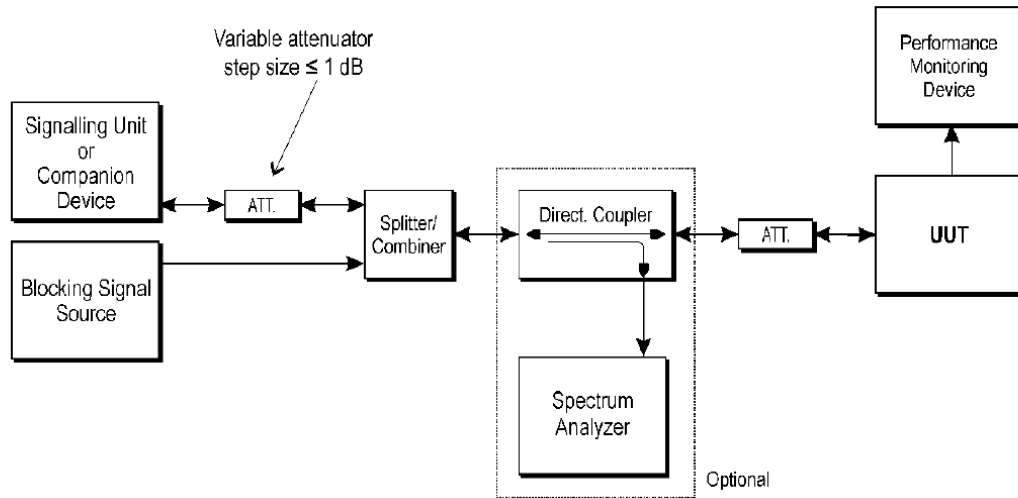

12.3 Test Procedure

For systems using multiple receive chains only one chain (antenna port) need to be tested. All other receiver inputs shall be terminated.

Figure 6 shows the test set-up which can be used for performing the receiver blocking test. The procedure in step 1 to step 6 below shall be used to verify the receiver blocking requirement as described in clause 4.3.1.12 or clause 4.3.2.11. The performance monitoring device is capable of verifying the performance criteria as defined in clause 4.3.1.12.3 or clause 4.3.2.11.3.

Table 6, table 7 and table 8 in clause 4.3.1.12.4 contain the applicable blocking frequencies and blocking levels for each of the receiver categories for testing Receiver Blocking on FHSS equipment.

Table 14, table 15 and table 16 in clause 4.3.2.11.4 contain the applicable blocking frequencies and blocking levels for each of the receiver categories for testing Receiver Blocking on non-FHSS equipment.

Step 1:

- For non-FHSS equipment, the UUT shall be set to the lowest operating channel on which the blocking test has to be performed (see clause 5.4.11.1).

Step 2:

- The blocking signal generator is set to the first frequency as defined in the appropriate table corresponding to the receiver category and type of equipment.

Step 3:

- With the blocking signal generator switched off, a communication link is established between the UUT and the associated companion device using the test setup shown in figure 6.
- Unless the option provided in note 2 of the applicable table referred to in clause 5.4.11.2.1 is used, the level of the wanted signal shall be set to the value provided in the table corresponding to the receiver category and type of equipment. The test procedure defined in clause 5.4.2, and more in particular clause 5.4.2.2.1.2, can be used to measure the (conducted) level of the wanted signal however no correction shall be made for antenna gain of the companion device (step 6 in clause 5.4.2.2.1.2 shall be ignored). This level may be measured directly at the output of the companion device and a correction is made for the coupling loss into the UUT.



The actual level for the wanted signal shall be recorded in the test report.

- When the option provided in note 2 of the applicable table referred to in clause 5.4.11.2.1 is used, the attenuation of the variable attenuator shall be increased in 1 dB steps to a value at which the minimum performance criteria as specified in clause 4.3.1.12.3 or clause 4.3.2.11.3 is still met. The resulting level for the wanted signal at the input of the UUT is P_{min} . This signal level (P_{min}) is increased by the value provided in note 2 of the applicable table corresponding to the receiver category and type of equipment.

Step 4:

- The blocking signal at the UUT is set to the level provided in the table corresponding to the receiver category and type of equipment.
- If the performance criteria as specified in clause 4.3.1.12.3 or clause 4.3.2.11.3 are met then proceed to step 6.

Step 5:

- If the performance criteria as specified in clause 4.3.1.12.3 or clause 4.3.2.11.3 is not met, step 3 and step 4 shall be repeated after that the frequency of the blocking signal set in step 2 has been increased with a value equal to the Occupied Channel Bandwidth except:
 - For the blocking frequency 2 380 MHz, where this frequency offset shall be less than or equal to 10 MHz. If this frequency offset is more than 7 MHz, the level of the wanted signal shall be increased by 3 dB.
 - For the blocking frequency 2 503,5 MHz, where this frequency offset shall be less than or equal to 10 MHz. If this frequency offset is more than 7 MHz, the level of the wanted signal shall be decreased by 3 dB.
- If the performance criteria as specified in clause 4.3.1.12.3 or clause 4.3.2.11.3 is still not met, step 3 and step 4 shall be repeated after that the frequency of the blocking signal set in step 2 has been decreased with a value equal to the Occupied Channel Bandwidth except:
 - For the blocking frequency 2 380 MHz, where this frequency offset shall be less than or equal to 10 MHz. If this frequency offset is more than 7 MHz, the level of the wanted signal shall be decreased by 3 dB.
 - For the blocking frequency 2 503,5 MHz, where this frequency offset shall be less than or equal to 10 MHz. If this frequency offset is more than 7 MHz, the level of the wanted signal shall be increased by 3 dB.
- If the performance criteria as specified in clause 4.3.1.12.3 or clause 4.3.2.11.3 is still not met, the UUT fails to comply with the Receiver Blocking requirement and step 6 and step 7 are no longer required.
- It shall be recorded in the test report whether the shift of blocking frequencies as described in the present step was used.

Step 6:

- Repeat step 4 and step 5 for each remaining combination of frequency and level for the blocking signal as provided in the table corresponding to the receiver category and type of equipment.

Step 7:

- For non-FHSS equipment, repeat step 2 to step 6 with the UUT operating at the highest operating channel on which the blocking test has to be performed (see clause 5.4.11.1).

Step 8:

- It shall be assessed and recorded in the test report whether the UUT complies with the Receiver Blocking requirement.

When performing radiated measurements on equipment with dedicated antennas,



measurements shall be repeated for each alternative dedicated antenna.

The power levels specified in table 6, table 7, table 8, table 14, table 15 and table 16 can be converted to a corresponding power flux density (PFD) value using the formula below:

$$\text{PFD} = P + 11 - 20 \times \log_{10}(300 / F)$$

'P' is the power level in dBm

'F' is the frequency in MHz

A test site as described in annex B and applicable measurement procedures as described in annex C shall be used.

The test procedure is further as described under clause 5.4.11.2.1.

The level of the blocking signal at the UUT referred to in step 4 equates to a corresponding field strength at the UUT antenna(s). The UUT shall be positioned with its main beam pointing towards the antenna radiating the blocking signal.

The position recorded in clause 5.4.2.2.2 can be used.

12.4 Deviation From Test Standard

No deviation

12.5 EUT Operating Mode

See clause 5.1 for the environmental test conditions. These measurements shall only be performed at normal test conditions. For non-FHSS equipment, having more than one operating channel, the operating channels on which the testing has to be performed shall be selected as follows:

- For testing blocking frequencies less than 2 400 MHz, the equipment shall operate on the lowest operating channel.
- For testing blocking frequencies greater than 2 500 MHz, the equipment shall operate on the highest operating channel.

Equipment which can change their operating channel automatically (adaptive channel allocation), and where this function cannot be disabled, shall be tested as a FHSS equipment.

If the equipment can be configured to operate with different Nominal Channel Bandwidths (e.g. 20 MHz and 40 MHz) and different data rates, then the combination of the smallest channel bandwidth and the lowest data rate for this channel bandwidth which still allows the equipment to operate as intended shall be used. This mode of operation shall be aligned with the performance criteria defined in clause 4.3.1.12.3 or clause 4.3.2.11.3 and shall be described in the test report.

12.6 Test Data

Please refer to the Appendix for BLE.



13 Geo-location Capability

13.1 Test Standard and Limit

13.1.1 Test Standard

ETSI EN 300 328 V2.2.2:2019 clause 4.3.2.12

13.1.2 Requirements

The geographical location determined by the non-FHSS equipment as defined in clause 4.3.2.12.2 shall not be accessible to the user in a way that would allow the user to alter it.

13.2 Deviation From Test Standard

No deviation

13.3 Test Data

The EUT is non-FHSS equipment without geo-location capability as defined in clause 4.3.2.12.2, So there is no requirement.



14 Transmitter Unwanted Emissions in the Spurious Domain

14.1 Test Standard and Limit

14.1.1 Test Standard

ETSI EN 300 328 V2.2.2:2019 clause 4.3.2.9

14.1.2 Test Limit

The transmitter unwanted emissions in the spurious domain shall not exceed the values given in table 12.

In case of equipment with antenna connectors, these limits apply to emissions at the antenna port (conducted). For emissions radiated by the cabinet or emissions radiated by integral antenna equipment (without antenna connectors), these limits are e.r.p. for emissions up to 1 GHz and as e.i.r.p. for emissions above 1 GHz.

Table 12: Transmitter limits for spurious emissions

Frequency range	Maximum power	Bandwidth
30 MHz to 47 MHz	-36 dBm	100 kHz
47 MHz to 74 MHz	-54 dBm	100 kHz
74 MHz to 87,5 MHz	-36 dBm	100 kHz
87,5 MHz to 118 MHz	-54 dBm	100 kHz
118 MHz to 174 MHz	-36 dBm	100 kHz
174 MHz to 230 MHz	-54 dBm	100 kHz
230 MHz to 470 MHz	-36 dBm	100 kHz
470 MHz to 694 MHz	-54 dBm	100 kHz
694 MHz to 1 GHz	-36 dBm	100 kHz
1 GHz to 12,75 GHz	-30 dBm	1 MHz

14.2 Test Setup

(A) Radiated Emission Test Set-Up Frequency Below 1 GHz.

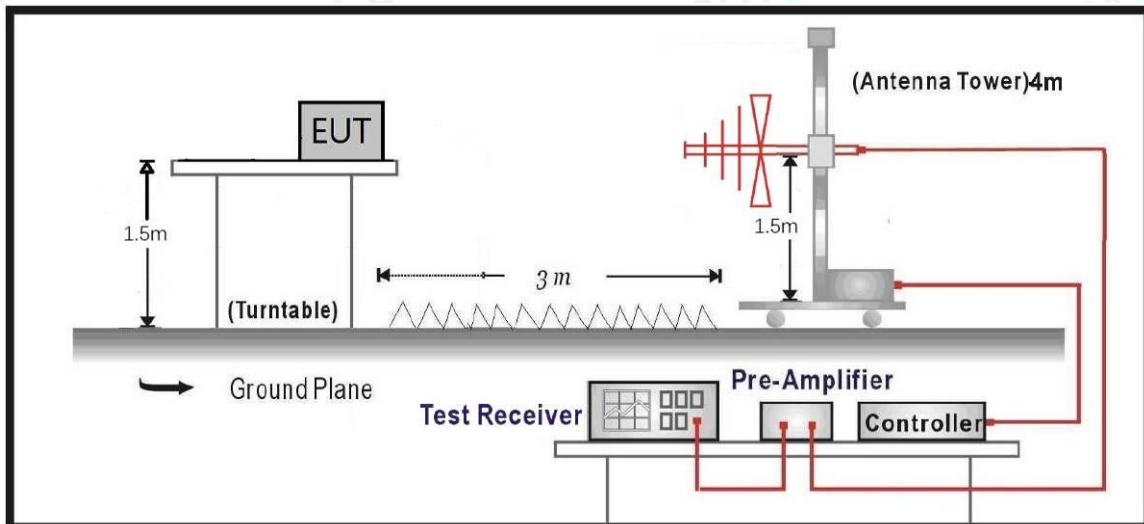

(B) Radiated Emission Test Set-Up Frequency Above 1 GHz.

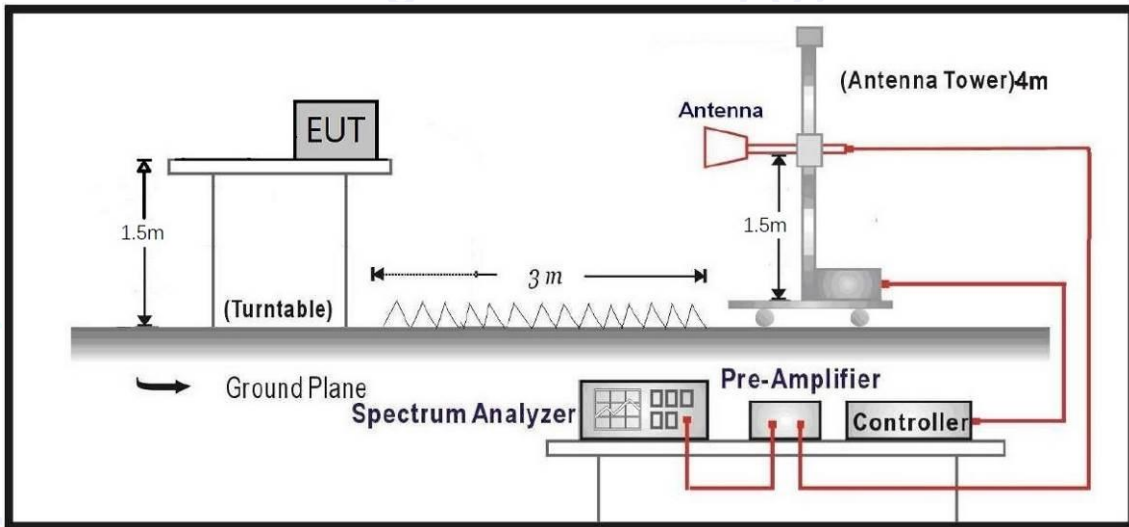

Conducted measurement

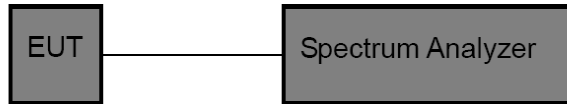

14.3 Test Procedure

Pre-scan

The procedure in step 1 to step 4 below shall be used to identify potential unwanted emissions of the UUT.

Step 1:

The sensitivity of the measurement set-up should be such that the noise floor is at least 12 dB below the limits given in table 4 or table 12.

Step 2:

The emissions over the range 30 MHz to 1 000 MHz shall be identified.

Spectrum analyser settings:

- Resolution bandwidth: 100 kHz
- Video bandwidth: 300 kHz
- Filter type: 3 dB (Gaussian)
- Detector mode: Peak
- Trace Mode: Max Hold
- Sweep Points: ≥ 19400 ; for spectrum analysers not supporting this high number of sweep points, the frequency band may be segmented.
- Sweep time: For non continuous transmissions (duty cycle less than 100 %), the sweep time shall be sufficiently long, such that for each 100 kHz frequency step, the measurement time is greater than two transmissions of the UUT, on any channel. For FHSS equipment operating in a normal operating (hopping not disabled) mode, the sweep time shall be further increased to capture multiple transmissions on any of the hopping frequencies.

The above sweep time setting may result in long measuring



times in case of FHSS equipment. To avoid such long measuring times, an FFT analyser may be used.

Allow the trace to stabilize. Any emissions identified during the sweeps above and that fall within the 6 dB range below the applicable limit or above, shall be individually measured using the procedure in clause 5.4.9.2.1.3 and compared to the limits given in table 4 or table 12.

Step 3:

The emissions over the range 1 GHz to 12,75 GHz shall be identified.

Spectrum analyser settings:

- Resolution bandwidth: 1 MHz
- Video bandwidth: 3 MHz
- Filter type: 3 dB (Gaussian)
- Detector mode: Peak
- Trace Mode: Max Hold
- Sweep Points: ≥ 23500 ; for spectrum analysers not supporting this high number of sweep points, the frequency band may be segmented.
- Sweep time: For non continuous transmissions (duty cycle less than 100 %), the sweep time shall be sufficiently long, such that for each 1 MHz frequency step, the measurement time is greater than two transmissions of the UUT, on any channel.

For FHSS equipment operating in a normal operating (hopping not disabled) mode, the sweep time shall be further increased to capture multiple transmissions on any of the hopping frequencies.

The above sweep time setting may result in long measuring times in case of FHSS equipment. To avoid such long measuring times, an FFT analyser may be used.

Allow the trace to stabilize. Any emissions identified during the sweeps above that fall within the 6 dB range below the applicable limit or above, shall be individually measured using the procedure in clause 5.4.9.2.1.3 and compared to the limits given in table 4 or table 12.

FHSS equipment may generate a block (or several blocks) of spurious emissions anywhere within the spurious domain.

If this is the case, only the highest peak of each block of emissions shall be measured using the procedure in clause 5.4.9.2.1.3.

Step 4:

- In case of conducted measurements on smart antenna systems (equipment with multiple transmit chains), step 2 and step 3 need to be repeated for each of the active transmit chains (A_{ch}). The limits used to identify emissions during this pre-scan need to be reduced by $10 \times \log_{10}(A_{ch})$.

Measurement of the emissions identified during the pre-scan

The procedure in step 1 to step 4 below shall be used to accurately measure the individual unwanted emissions identified during the pre-scan measurements above. This method assumes the spectrum analyser has a Time Domain Power function.

Step 1:

The level of the emissions shall be measured using the following spectrum analyser settings:



-
- Measurement Mode: Time Domain Power
 - Centre Frequency: Frequency of the emission identified during the pre-scan
 - Resolution Bandwidth: 100 kHz (< 1 GHz) / 1 MHz (> 1 GHz)
 - Video Bandwidth : 300 kHz (< 1 GHz) / 3 MHz (> 1 GHz)
 - Frequency Span: Zero Span
 - Sweep Mode: Single Sweep
 - Sweep Time: >120 % of the duration of the longest burst detected during the measurement of the RF Output Power
 - Sweep Points: Sweep time [µs] / (1 µs) with a maximum of 30 000
 - Trigger Mode: Video (burst signals) or Manual (continuous signals)
 - Detector Mode: RMS

Step 2:

Set a window where the start and stop indicators match the start and end of the burst with the highest level and record the value of the power measured within this window. If the spurious emission to be measured is a continuous transmission, the measurement window shall be set to match the start and stop times of the sweep.

Step 3:

In case of conducted measurements on smart antenna systems (equipment with multiple transmit chains), step 2 needs to be repeated for each of the active transmit chains (Ach). Sum the measured power (within the observed window) for each of the active transmit chains.

Step 4:

The value defined in step 3 shall be compared to the limits defined in table 4 or table 12.

14.4 Deviation From Test Standard

No deviation

14.5 EUT Operating Mode

These measurements shall only be performed at normal test conditions.

The level of spurious emissions shall be measured as, either:

- a) their power in a specified load (conducted spurious emissions) and their effective radiated power when radiated by the cabinet or structure of the equipment (cabinet radiation); or
- b) their effective radiated power when radiated by cabinet and antenna in case of integral antenna equipment with no antenna connectors.

The equipment shall be configured to operate under its worst case situation with respect to output power.

14.6 Test Data

Please refer to the following pages.



(1) Below 1 G

Test Voltage:	DC 5.0V
Ant. Pol.	Horizontal
Test Mode:	TX BLE(1Mbps) Mode 2402MHz
Remark:	Only showed the worst mode test data.

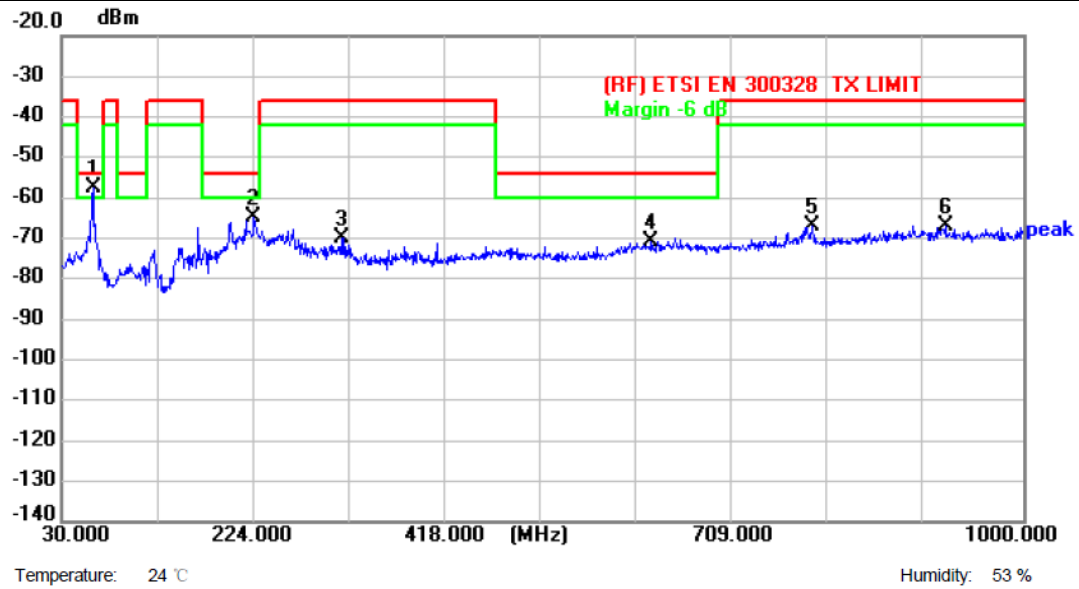

No.	Frequency (MHz)	Reading (dBm)	Factor (dB)	Level (dBm)	Limit (dBm)	Margin (dB)	Detector	P/F
1 *	62.0100	-46.61	-10.79	-57.40	-54.00	-3.40	peak	P
2	224.0000	-54.15	-10.47	-64.62	-54.00	-10.62	peak	P
3	312.2700	-61.96	-7.82	-69.78	-36.00	-33.78	peak	P
4	624.6100	-68.91	-1.75	-70.66	-54.00	-16.66	peak	P
5	787.5700	-66.60	-0.25	-66.85	-36.00	-30.85	peak	P
6	921.4300	-68.27	1.48	-66.79	-36.00	-30.79	peak	P

Remark:
 1. Corr. = Antenna Factor (dB) + Cable Loss (dB)
 2. Margin (dB) = Peak(dBm) - Limit (dBm)



Test Voltage:	DC 5.0V
Ant. Pol.	Vertical
Test Mode:	TX BLE(1Mbps) Mode 2402MHz
Remark:	Only showed the worst mode test data.

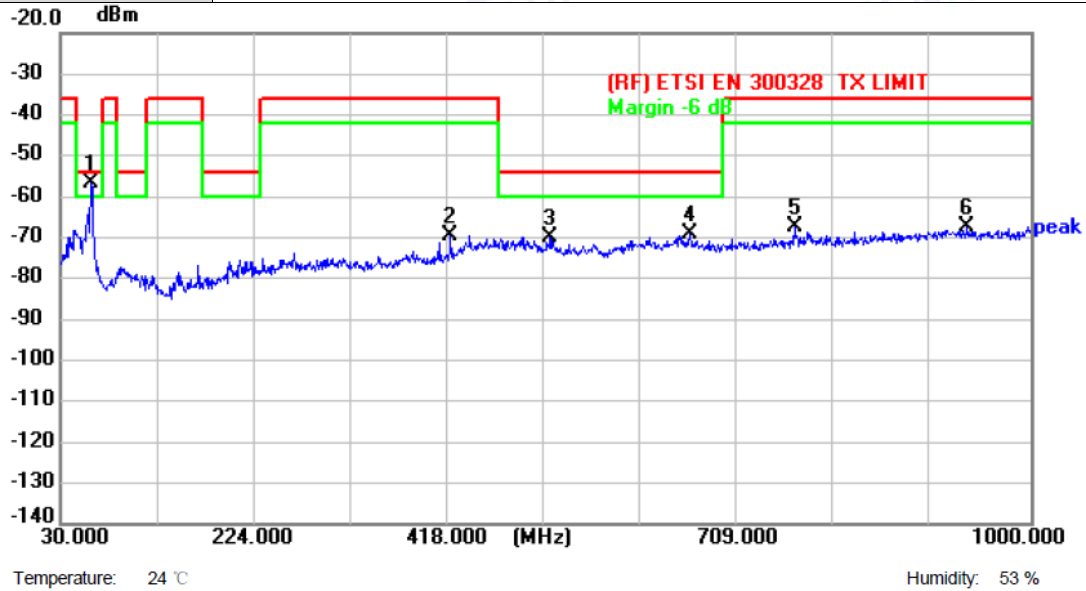

No.	Frequency (MHz)	Reading (dBm)	Factor (dB)	Level (dBm)	Limit (dBm)	Margin (dB)	Detector	P/F
1 *	60.0700	-46.96	-9.81	-56.77	-54.00	-2.77	peak	P
2	419.9400	-63.05	-6.46	-69.51	-36.00	-33.51	peak	P
3	519.8500	-65.32	-4.42	-69.74	-54.00	-15.74	peak	P
4	659.5300	-66.93	-2.33	-69.26	-54.00	-15.26	peak	P
5	764.2900	-67.24	-0.24	-67.48	-36.00	-31.48	peak	P
6	936.9500	-69.22	1.67	-67.55	-36.00	-31.55	peak	P

Remark:
 1. Corr. = Antenna Factor (dB) + Cable Loss (dB)
 2. Margin (dB) = Peak(dBm) - Limit (dBm)



(2) Above 1 GHz

Only showed the worst mode test data.

Test Voltage:	DC 5.0V
Ant. Pol.	Horizontal
Test Mode:	TX BLE(1Mbps) Mode 2402MHz
Remark:	No report for the emission which below the prescribed limit.

Temperature: 24 °C Humidity: 53 %

No.	Frequency (MHz)	Reading (dBm)	Factor (dB)	Level (dBm)	Limit (dBm)	Margin (dB)	Detector	P/F
1 *	10928.7500	-60.33	15.34	-44.99	-30.00	-14.99	peak	P
2	12303.5000	-63.28	18.02	-45.26	-30.00	-15.26	peak	P

Remark:

1. Corr. = Antenna Factor (dB) + Cable Loss (dB)
2. Margin (dB) = Peak(dBm) - Limit (dBm)
3. The tests evaluated 1~12.75GHz, Test with highpass filter (Pass Frequency: 2.8-18G).
4. No report for the emission which below the prescribed limit.



Test Voltage:	DC 5.0V
Ant. Pol.	Vertical
Test Mode:	TX BLE(1Mbps) Mode 2402MHz
Remark:	No report for the emission which below the prescribed limit.

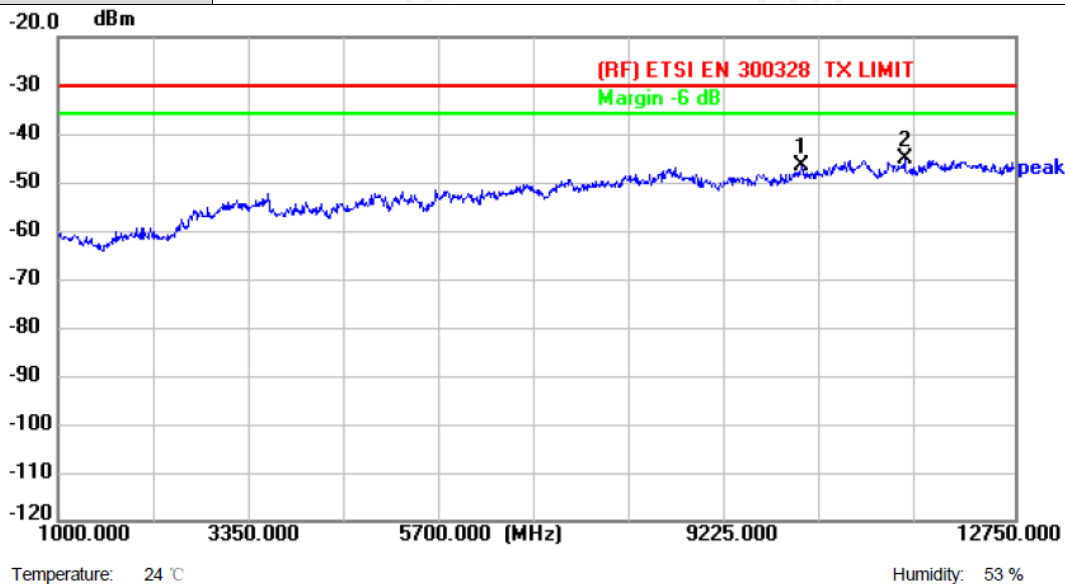

No.	Frequency (MHz)	Reading (dBm)	Factor (dB)	Level (dBm)	Limit (dBm)	Margin (dB)	Detector	P/F
1	10129.7500	-59.81	13.29	-46.52	-30.00	-16.52	peak	P
2 *	11398.7500	-62.22	16.96	-45.26	-30.00	-15.26	peak	P

Remark:

1. Corr. = Antenna Factor (dB) + Cable Loss (dB)
2. Margin (dB) = Peak(dBm) - Limit (dBm)
3. The tests evaluated 1~12.75GHz, Test with highpass filter (Pass Frequency: 2.8-18G).
4. No report for the emission which below the prescribed limit.



Test Voltage:	DC 5.0V
Ant. Pol.	Horizontal
Test Mode:	TX BLE(1Mbps) Mode 2480MHz
Remark:	No report for the emission which below the prescribed limit.

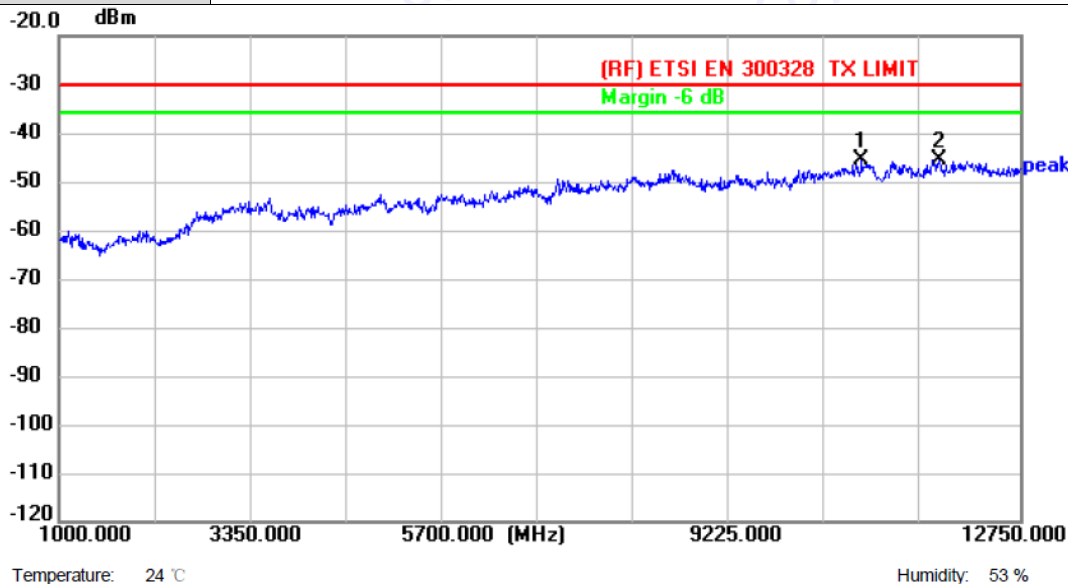

No.	Frequency (MHz)	Reading (dBm)	Factor (dB)	Level (dBm)	Limit (dBm)	Margin (dB)	Detector	P/F
1	10811.2500	-60.34	14.67	-45.67	-30.00	-15.67	peak	P
2 *	11763.0000	-63.25	17.75	-45.50	-30.00	-15.50	peak	P

Remark:

1. Corr. = Antenna Factor (dB) + Cable Loss (dB)
2. Margin (dB) = Peak(dBm) - Limit (dBm)
3. The tests evaluated 1~12.75GHz, Test with highpass filter (Pass Frequency: 2.8-18G).
4. No report for the emission which below the prescribed limit.



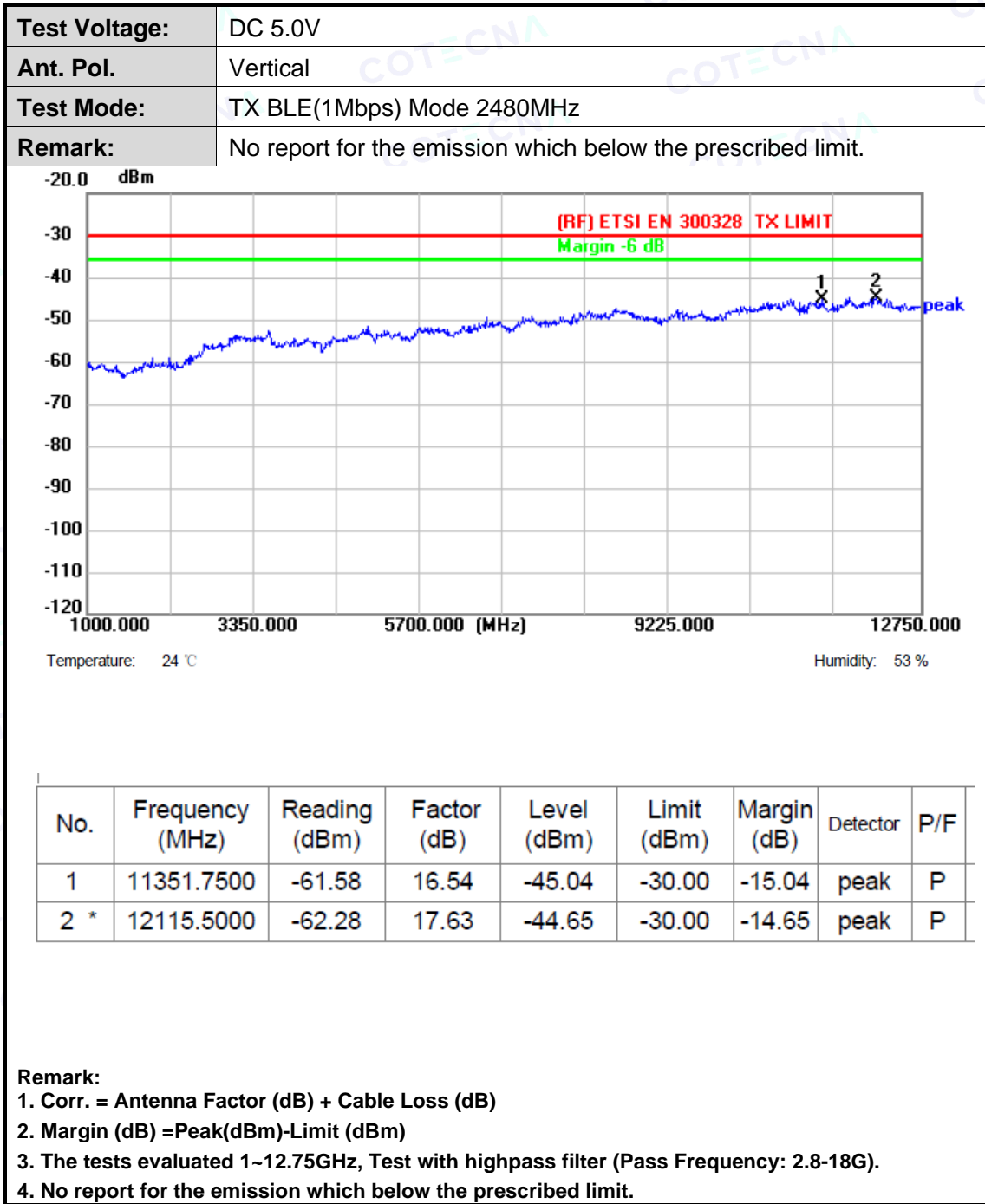

15 Receiver Spurious Emissions

15.1 Test Standard and Limit

15.1.1 Test Standard

ETSI EN 300 328 V2.2.2:2019 clause 4.3.2.10

15.1.2 Test Limit

The spurious emissions of the receiver shall not exceed the values given in table 13.

In case of non-FHSS equipment with antenna connectors, these limits apply to emissions at the antenna port (conducted). For emissions radiated by the cabinet or for emissions radiated by integral antenna equipment (without antenna connectors), these limits are e.r.p. for emissions up to 1 GHz and e.i.r.p. for emissions above 1 GHz.

Table 13: Spurious emission limits for receivers

Frequency range	Maximum power	Bandwidth
30 MHz to 1 GHz	-57 dBm	100 kHz
1 GHz to 12,75 GHz	-47 dBm	1 MHz

15.2 Test Setup

(A) Radiated Emission Test Set-Up Frequency Below 1 GHz.

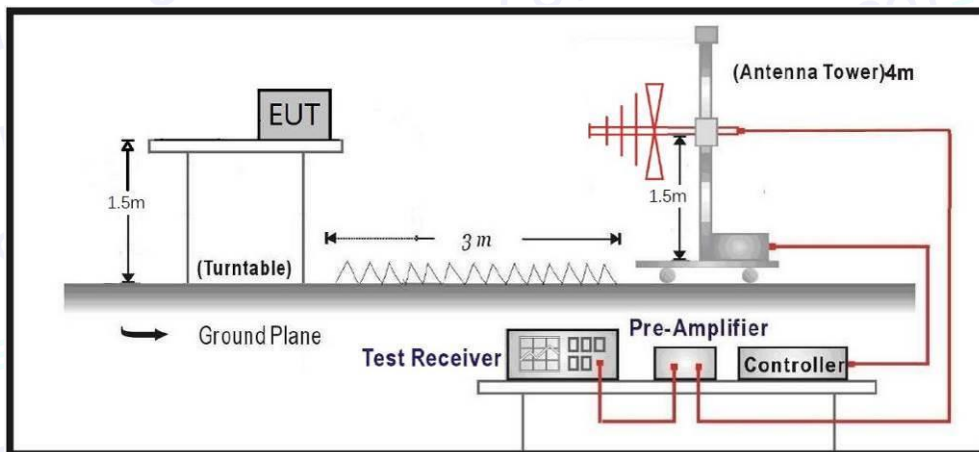

(B) Radiated Emission Test Set-Up Frequency Above 1 GHz.

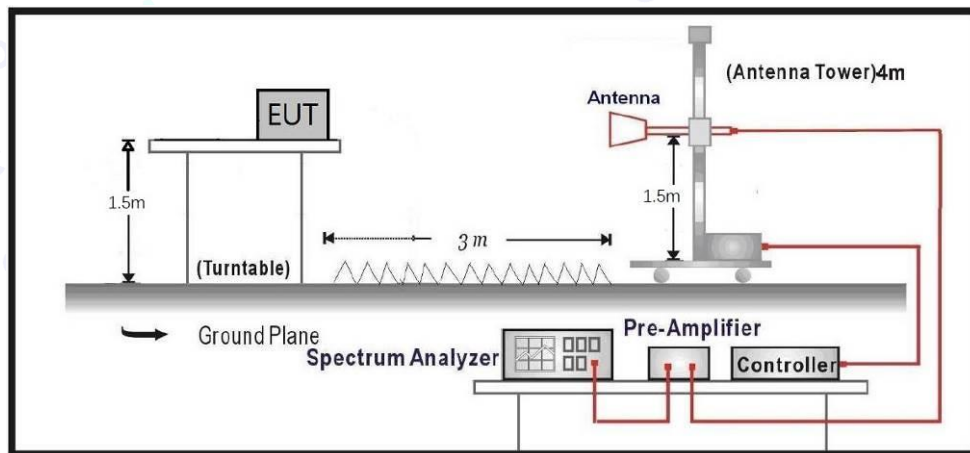

Conducted measurement

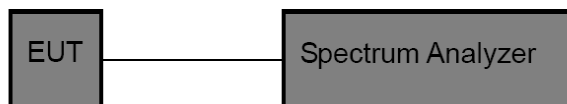

15.3 Test Procedure

Pre-scan

The procedure in step 1 to step 4 below shall be used to identify potential unwanted emissions of the UUT.

Step 1:

The sensitivity of the measurement set-up should be such that the noise floor is at least 12 dB below the limits given in table 5 or table 13.

Step 2:

The emissions over the range 30 MHz to 1000 MHz shall be identified.

Spectrum analyser settings:

- Resolution bandwidth: 100 kHz
- Video bandwidth: 300 kHz
- Filter type: 3 dB (Gaussian)
- Detector mode: Peak
- Trace Mode: Max Hold
- Sweep Points: ≥ 19400 ;
- Sweep time: Auto

Wait for the trace to stabilize. Any emissions identified during the sweeps above and that fall within the 6 dB range below the applicable limit or above, shall be individually measured using the procedure in clause 5.4.10.2.1.3 and compared to the limits given in table 5 or table 13.

Step 3:

The emissions over the range 1 GHz to 12,75 GHz shall be identified.

Spectrum analyser settings:

- Resolution bandwidth: 1 MHz
- Video bandwidth: 3 MHz
- Filter type: 3 dB (Gaussian)
- Detector mode: Peak
- Trace Mode: Max Hold
- Sweep Points: ≥ 23500 ; for spectrum analysers not supporting this high number of sweep points, the frequency band may be segmented.
- Sweep time: Auto

Wait for the trace to stabilize. Any emissions identified during the sweeps above that fall within the 6 dB range below the applicable limit or above, shall be individually measured using the procedure in clause 5.4.10.2.1.3 and compared to the limits given in table 5 or table 13.

FHSS equipment may generate a block (or several blocks) of spurious emissions anywhere within the spurious domain. If this is the case, only the highest peak of each block of emissions shall be measured using the procedure in clause 5.4.10.2.1.3.

Step 4:

- In case of conducted measurements on smart antenna systems (equipment with multiple transmit chains), step 2 and step 3 need to be repeated for each of the active transmit chains (A_{ch}). The limits used to identify emissions during this pre-scan need to be reduced by $10 \times \log_{10}(A_{ch})$.



Measurement of the emissions identified during the pre-scan

The procedure in step 1 to step 4 below shall be used to accurately measure the individual unwanted emissions identified during the pre-scan measurements above. This method assumes the spectrum analyser has a Time Domain Power function.

Step 1:

The level of the emissions shall be measured using the following spectrum analyser settings:

- Measurement Mode: Time Domain Power
- Centre Frequency: Frequency of the emission identified during the pre-scan
- Resolution Bandwidth: 100 kHz (< 1 GHz) / 1 MHz (> 1 GHz)
- Video Bandwidth : 300 kHz (< 1 GHz) / 3 MHz (> 1 GHz)
- Frequency Span: Zero Span
- Sweep Mode: Single Sweep
- Sweep Time: 30ms
- Sweep Points: ≥ 30000
- Trigger Mode: Video (burst signals) or Manual (continuous signals)
- Detector Mode: RMS

Step 2:

Set a window where the start and stop indicators match the start and end of the burst with the highest level and record the value of the power measured within this window. If the spurious emission to be measured is a continuous transmission, the measurement window shall be set to match the start and stop times of the sweep.

Step 3:

In case of conducted measurements on smart antenna systems (equipment with multiple transmit chains), step 2 needs to be repeated for each of the active transmit chains (Ach). Sum the measured power (within the observed window) for each of the active transmit chains.

Step 4:

The value defined in step 3 shall be compared to the limits defined in table 5 or table 13.

15.4 Deviation From Test Standard

No deviation

15.5 EUT Operating Mode

These measurements shall only be performed at normal test conditions.

The level of spurious emissions shall be measured as, either:

- a) their power in a specified load (conducted spurious emissions) and their effective radiated power when radiated by the cabinet or structure of the equipment (cabinet radiation); or
- b) their effective radiated power when radiated by cabinet and antenna in case of integral antenna equipment with no antenna connectors.

Testing shall be performed when the equipment is in a receive-only mode.

For non-FHSS equipment, the measurement shall be performed at the lowest and the highest channel on which the equipment can operate. These frequencies shall be recorded.

For FHSS equipment, the measurements may be performed when normal hopping is disabled. In this case measurements need to be performed when operating at the lowest and the highest hopping frequency. These frequencies shall be recorded. When disabling the normal hopping is not possible, the measurement shall be performed during normal operation (hopping).

15.6 Test Data

Please refer to the following pages.



(1) Below 1 G

Test Voltage:	DC 5.0V
Ant. Pol.	Horizontal
Test Mode:	RX BLE(1Mbps) Mode 2402MHz
Remark:	Only showed the worst mode test data.

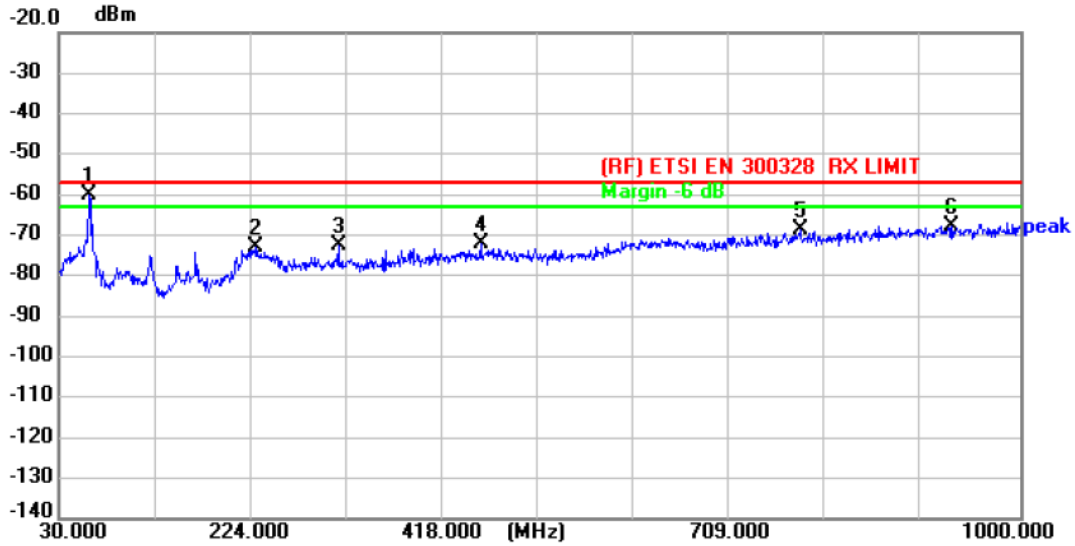

Temperature: 24 °C

Humidity: 53 %

No.	Frequency (MHz)	Reading (dBm)	Factor (dB)	Level (dBm)	Limit (dBm)	Margin (dB)	Detector	P/F
1 *	60.0700	-50.31	-9.84	-60.15	-57.00	-3.15	peak	P
2	227.8800	-63.01	-10.09	-73.10	-57.00	-16.10	peak	P
3	312.2700	-64.65	-7.82	-72.47	-57.00	-15.47	peak	P
4	455.8300	-67.02	-5.20	-72.22	-57.00	-15.22	peak	P
5	777.8700	-68.27	-0.26	-68.53	-57.00	-11.53	peak	P
6	931.1300	-69.18	1.46	-67.72	-57.00	-10.72	peak	P

Remark:

1. Corr. = Antenna Factor (dB) + Cable Loss (dB)

2. Margin (dB) = Peak(dBm) - Limit (dBm)



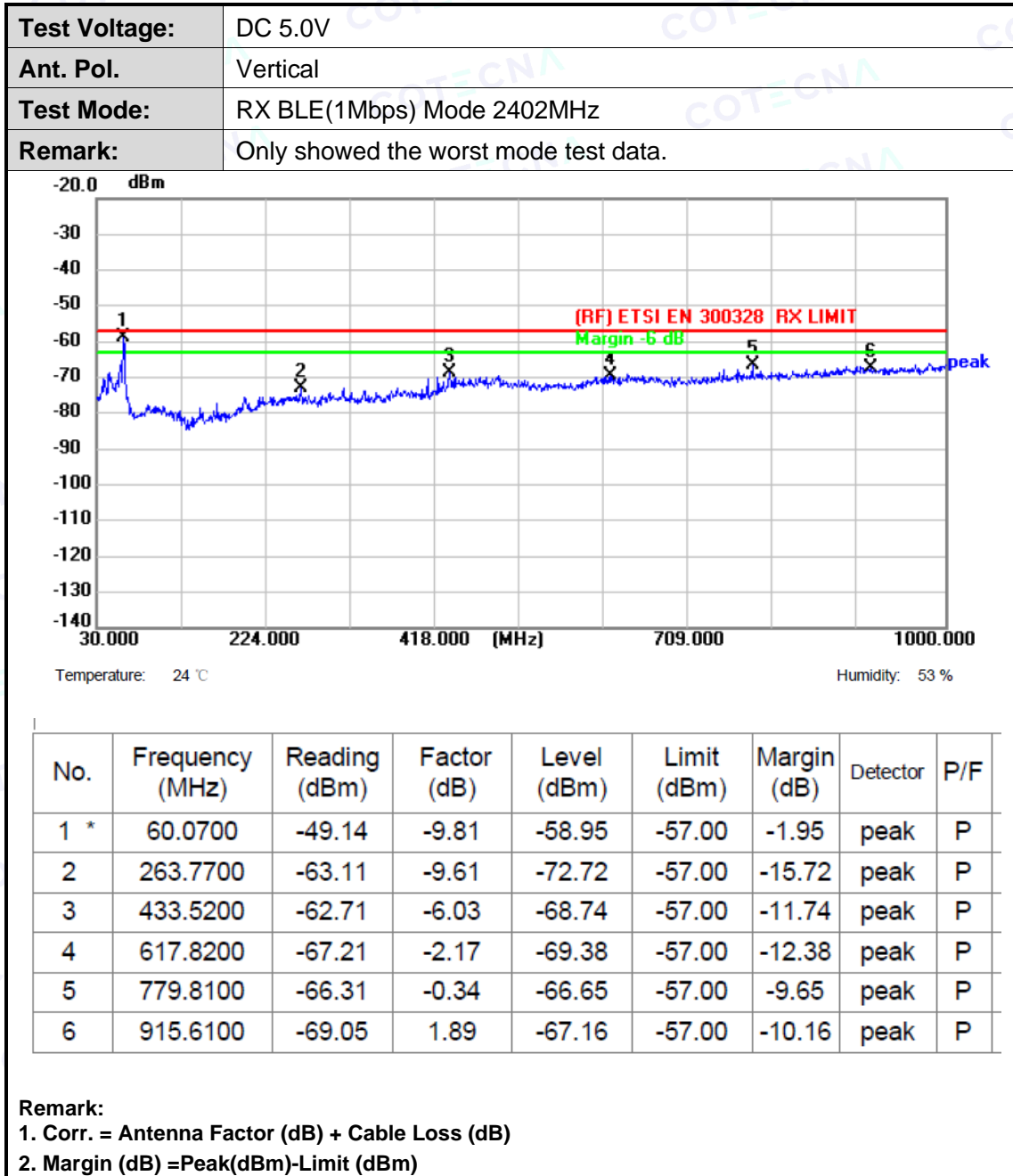

(2) Above 1 GHz

Only showed the worst mode test data.

Test Voltage:	DC 5.0V
Ant. Pol.	Horizontal
Test Mode:	RX BLE Mode 2402MHz
Remark:	No report for the emission which below the prescribed limit.

No.	Frequency (MHz)	Reading (dBm)	Factor (dB)	Level (dBm)	Limit (dBm)	Margin (dB)	Detector	P/F
1 *	10893.5000	-64.01	9.62	-54.39	-47.00	-7.39	peak	P
2	11716.0000	-66.07	11.62	-54.45	-47.00	-7.45	peak	P

Remark:

1. Corr. = Antenna Factor (dB) + Cable Loss (dB)
2. Margin (dB) = Peak(dBm) - Limit (dBm)
3. The tests evaluated 1~12.75GHz, Test with highpass filter (Pass Frequency: 2.8-18G).
4. No report for the emission which below the prescribed limit.



Test Voltage:	DC 5.0V
Ant. Pol.	Vertical
Test Mode:	RX BLE Mode 2402MHz
Remark:	No report for the emission which below the prescribed limit.

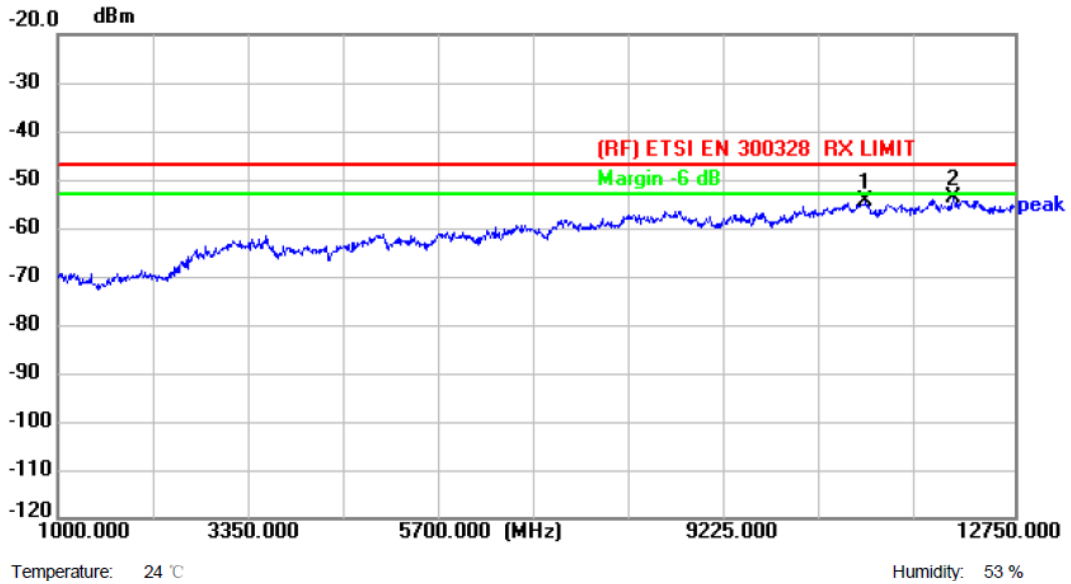

No.	Frequency (MHz)	Reading (dBm)	Factor (dB)	Level (dBm)	Limit (dBm)	Margin (dB)	Detector	P/F
1	10917.0000	-63.48	9.13	-54.35	-47.00	-7.35	peak	P
2 *	11998.0000	-65.85	12.15	-53.70	-47.00	-6.70	peak	P

Remark:

1. Corr. = Antenna Factor (dB) + Cable Loss (dB)
2. Margin (dB) = Peak(dBm) - Limit (dBm)
3. The tests evaluated 1~12.75GHz, Test with highpass filter (Pass Frequency: 2.8-18G).
4. No report for the emission which below the prescribed limit.



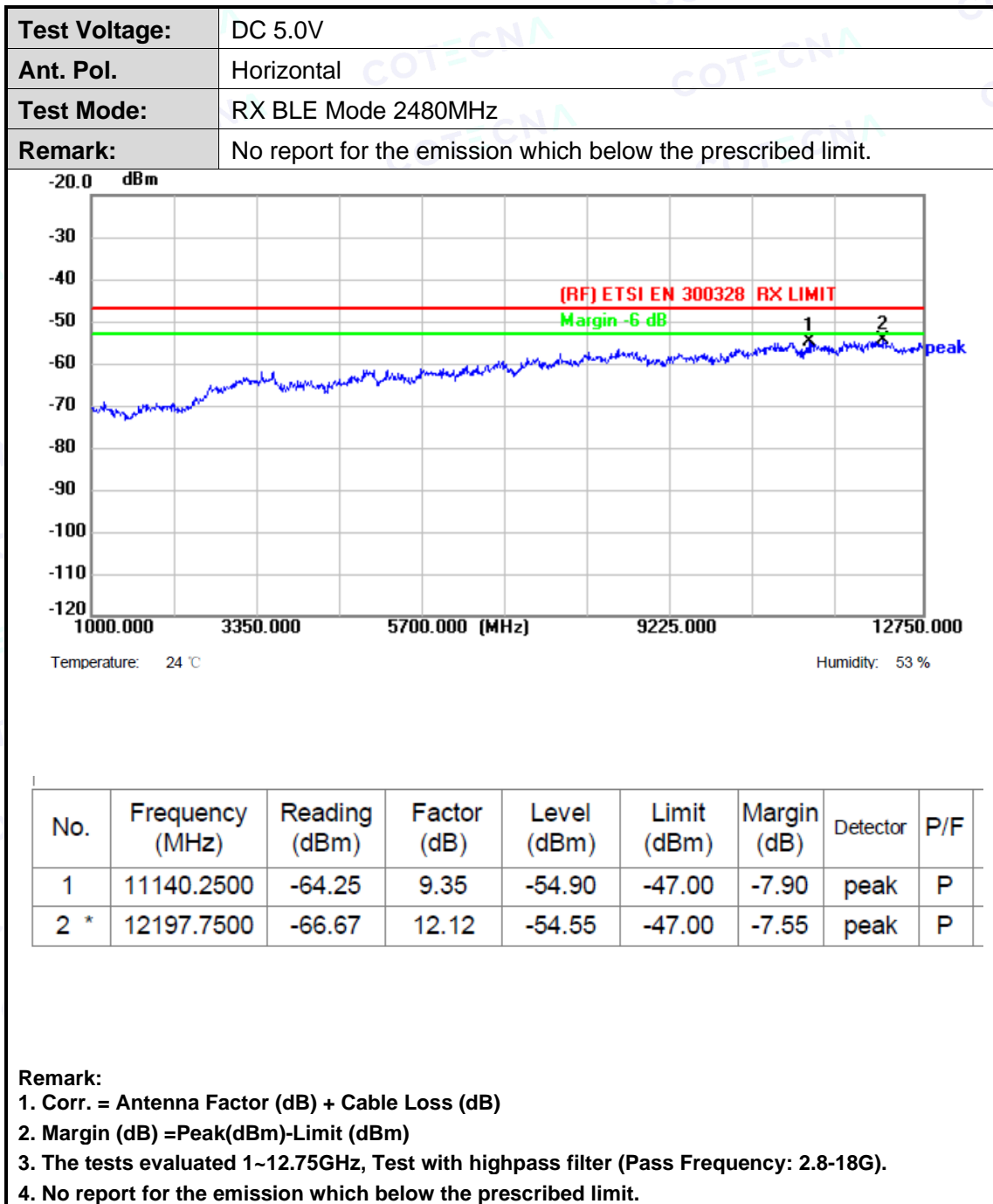

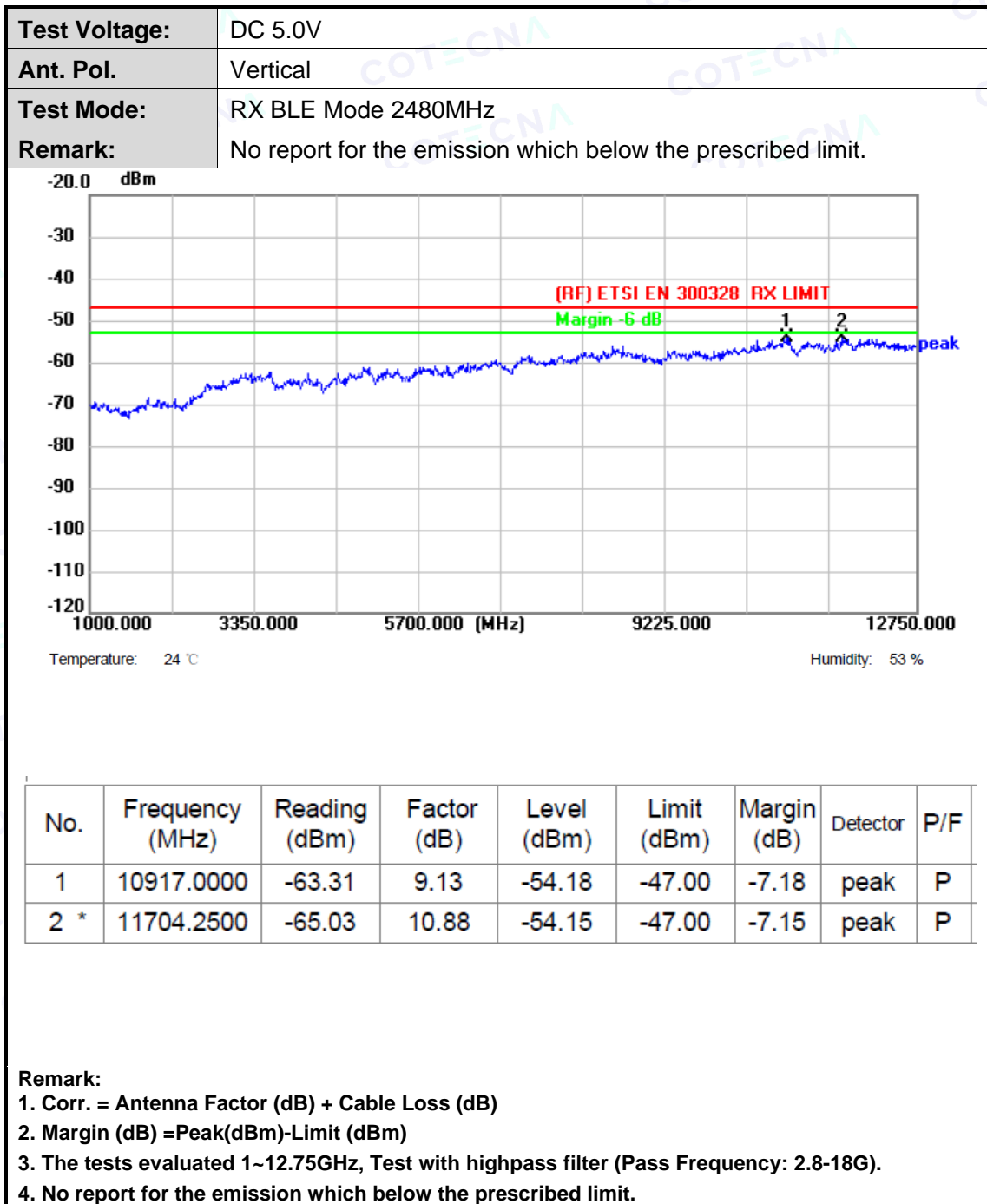

16 Photographs--Test Setup

Radiated Spurious Emission (Below 1 GHz)

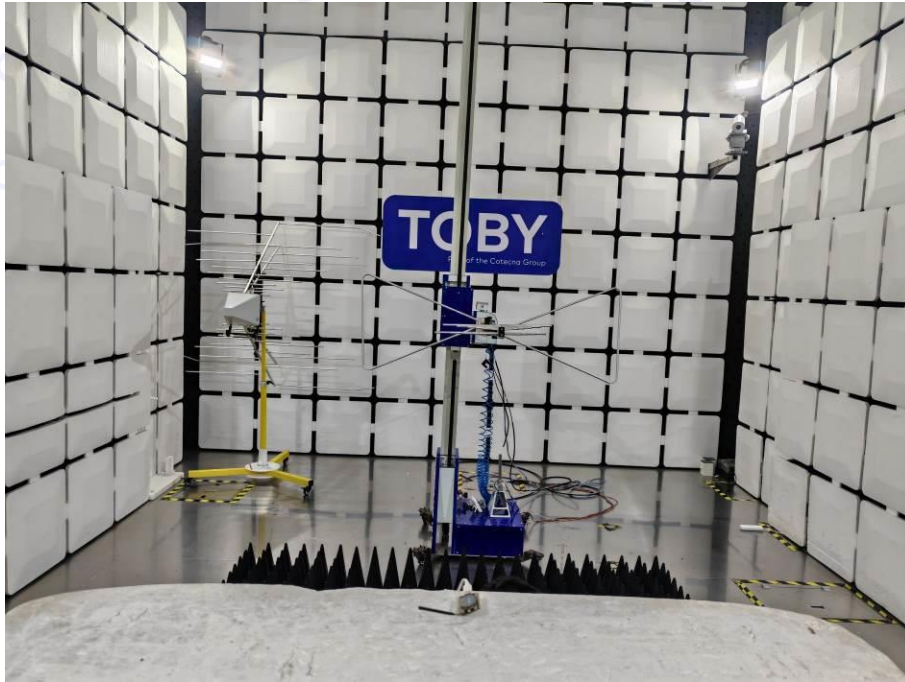

Radiated Spurious Emission (Above 1 GHz)

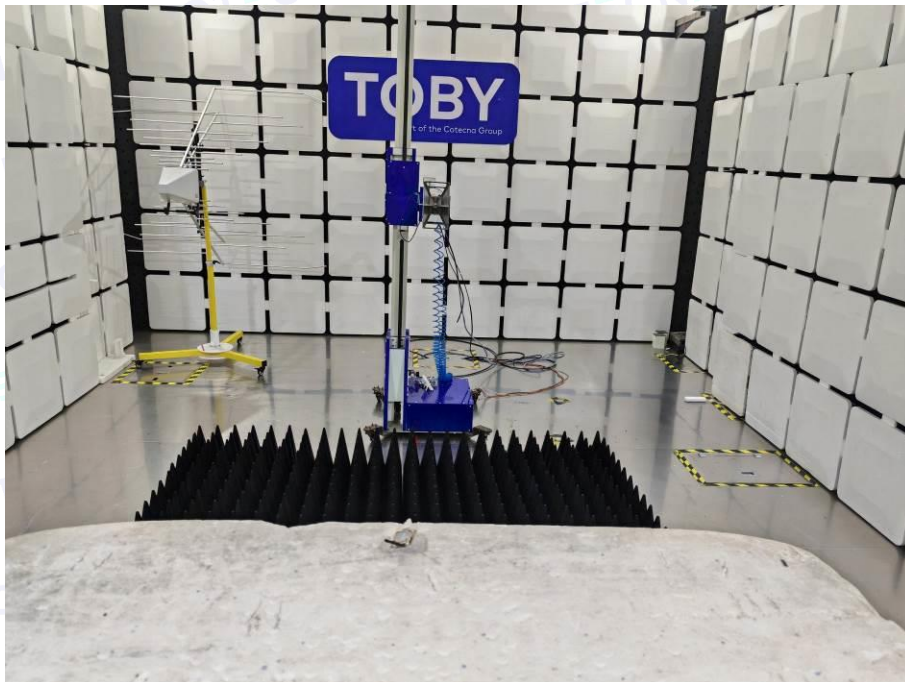

-----END OF THE REPORT-----

